

CSE 512 - Data Visualization

Graphical Perception

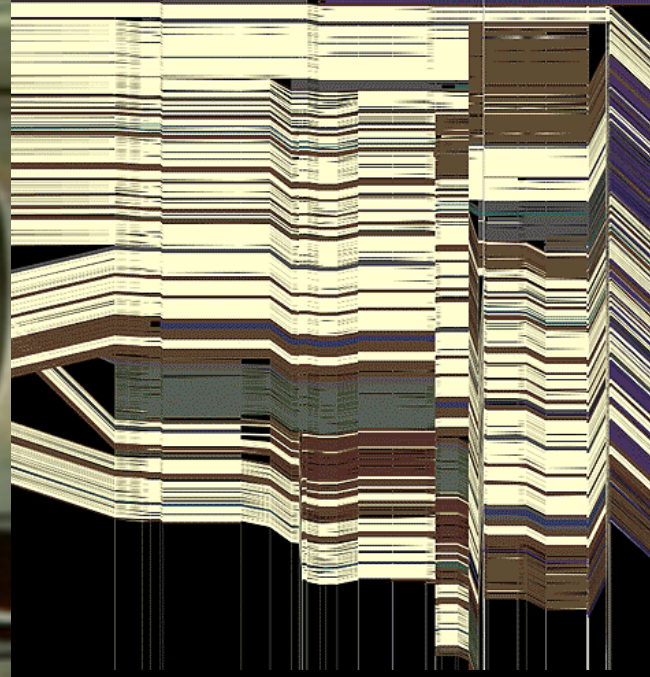
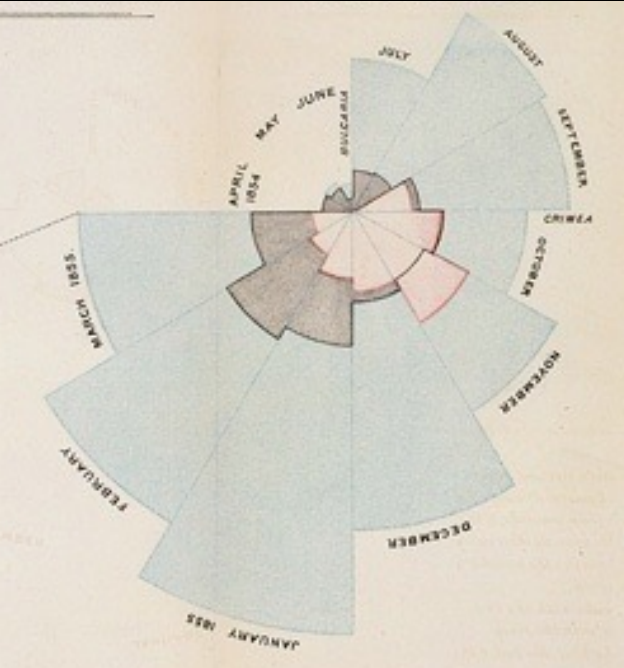

Jeffrey Heer University of Washington

Design Principles [Mackinlay 86]

Expressiveness

A set of facts is *expressible* in a visual language if the sentences (i.e. the visualizations) in the language express all the facts in the set of data, and only the facts in the data.

Effectiveness

A visualization is more *effective* than another visualization if the information conveyed by one visualization is more readily perceived than the information in the other visualization.

Design Principles *Translated*

Tell the truth and nothing but the truth
(don't lie, and don't lie by omission)

Use encodings that people decode better
(where better = faster and/or more accurate)

Which best encodes quantities?

Position

Length

Area

Volume

Value (Brightness)

Color Hue

Orientation (Angle)

Shape

Effectiveness Rankings [Mackinlay 86]

QUANTITATIVE

Position
Length
Angle
Slope
Area (Size)
Volume
Density (Value)
Color Sat
Color Hue
Texture
Connection
Containment
Shape

ORDINAL

Position
Density (Value)
Color Sat
Color Hue
Texture
Connection
Containment
Length
Angle
Slope
Area (Size)
Volume
Shape

NOMINAL

Position
Color Hue
Texture
Connection
Containment
Density (Value)
Color Sat
Shape
Length
Angle
Slope
Area
Volume

Graphical Perception

The ability of viewers to interpret visual (graphical) encodings of information and thereby decode information in graphs.

Topics

Signal Detection

Magnitude Estimation

Pre-Attentive Processing

Using Multiple Visual Encodings

Gestalt Grouping

Change Blindness

Detection

Detecting Brightness



Which is brighter?

Detecting Brightness

(128, 128, 128)



(144, 144, 144)



Which is brighter?



Detecting Brightness

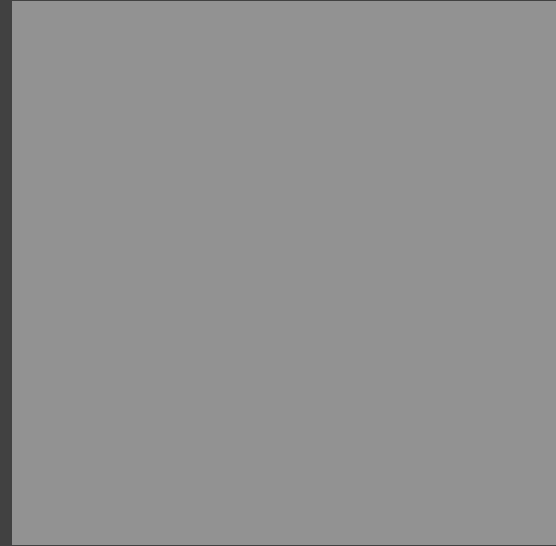
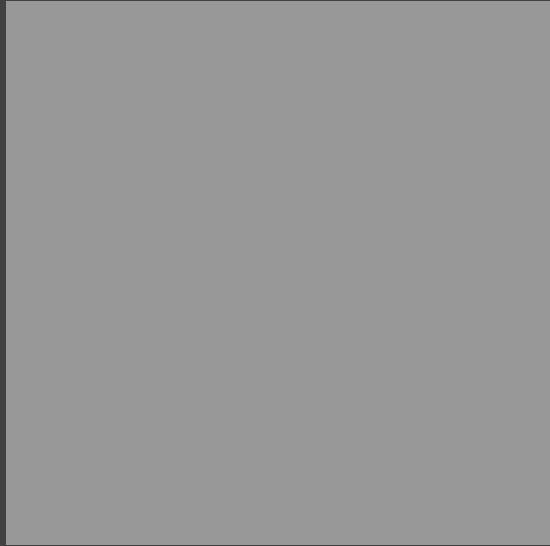

Which is brighter?

Detecting Brightness

(134, 134, 134)

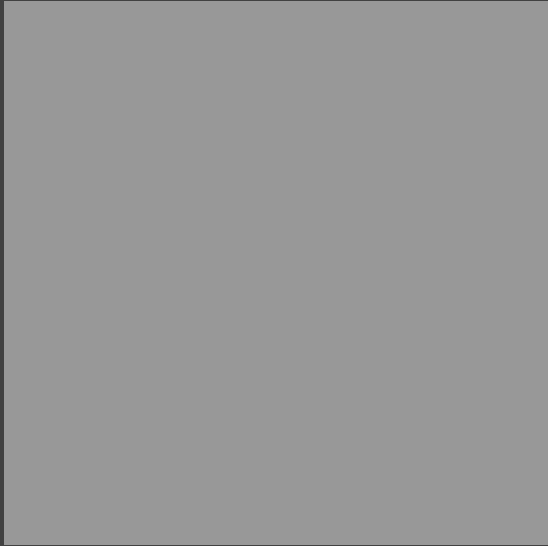

(128, 128, 128)

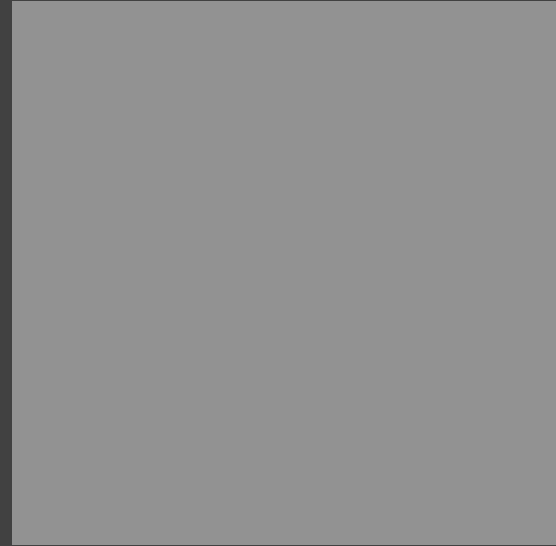

Which is brighter?

Just Noticeable Difference (JND)

JND (Weber's Law)

$$\Delta S = k \frac{\Delta I}{I}$$

Ratios more important than magnitude

Most continuous variation in stimuli are
perceived in discrete steps



Encoding Data with Color

Value is perceived as ordered

∴ Encode ordinal variables (O)

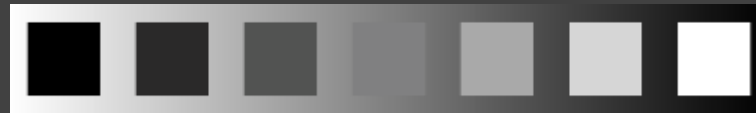

∴ Encode continuous variables (Q) [not as well]

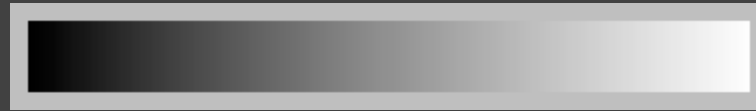

Hue is normally perceived as unordered

∴ Encode nominal variables (N) using color



Steps in Font Size

Sizes standardized in 16th century



Magnitude Estimation

A Quick Experiment...

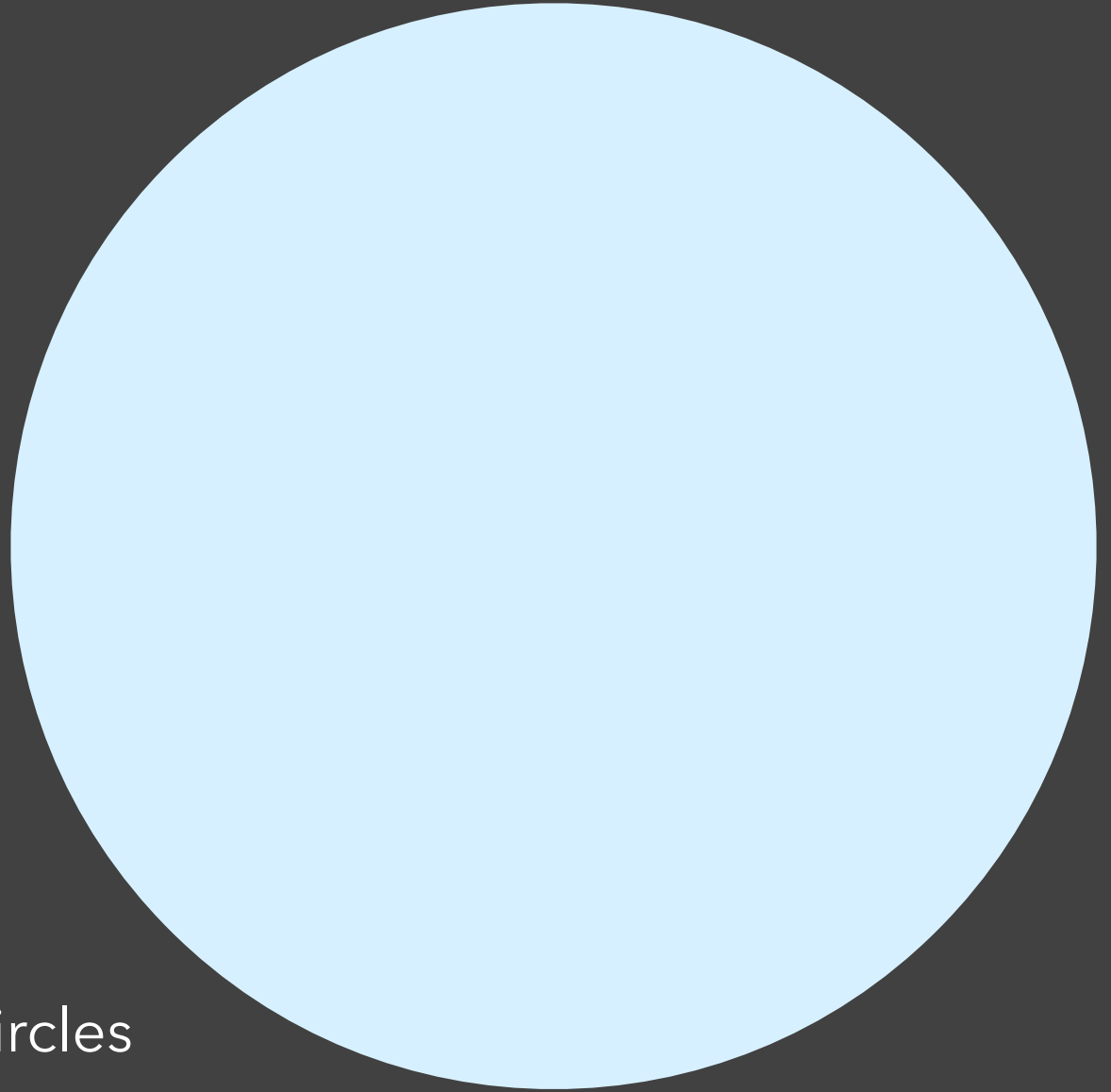
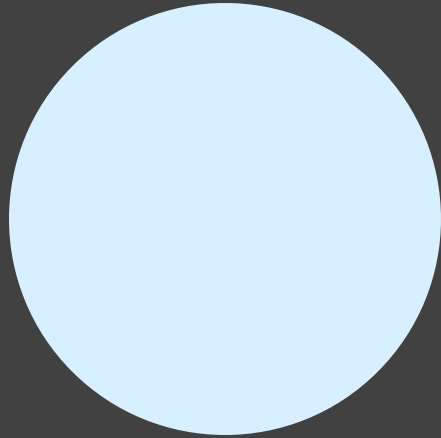

Compare area of circles

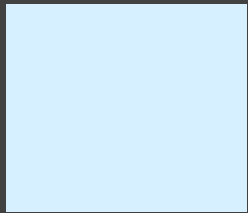
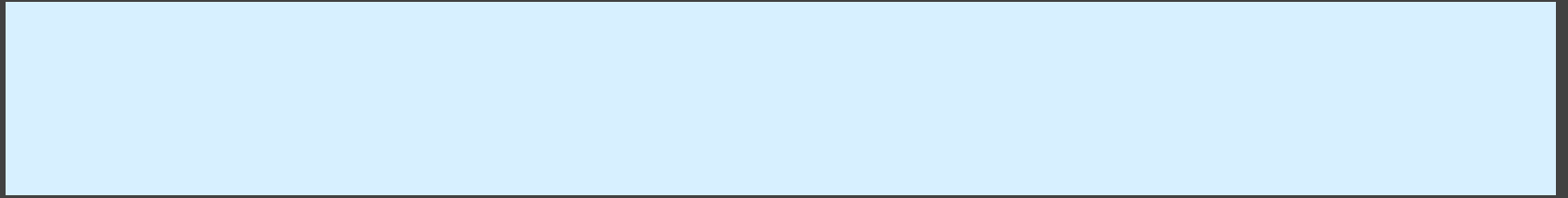

Compare length of bars

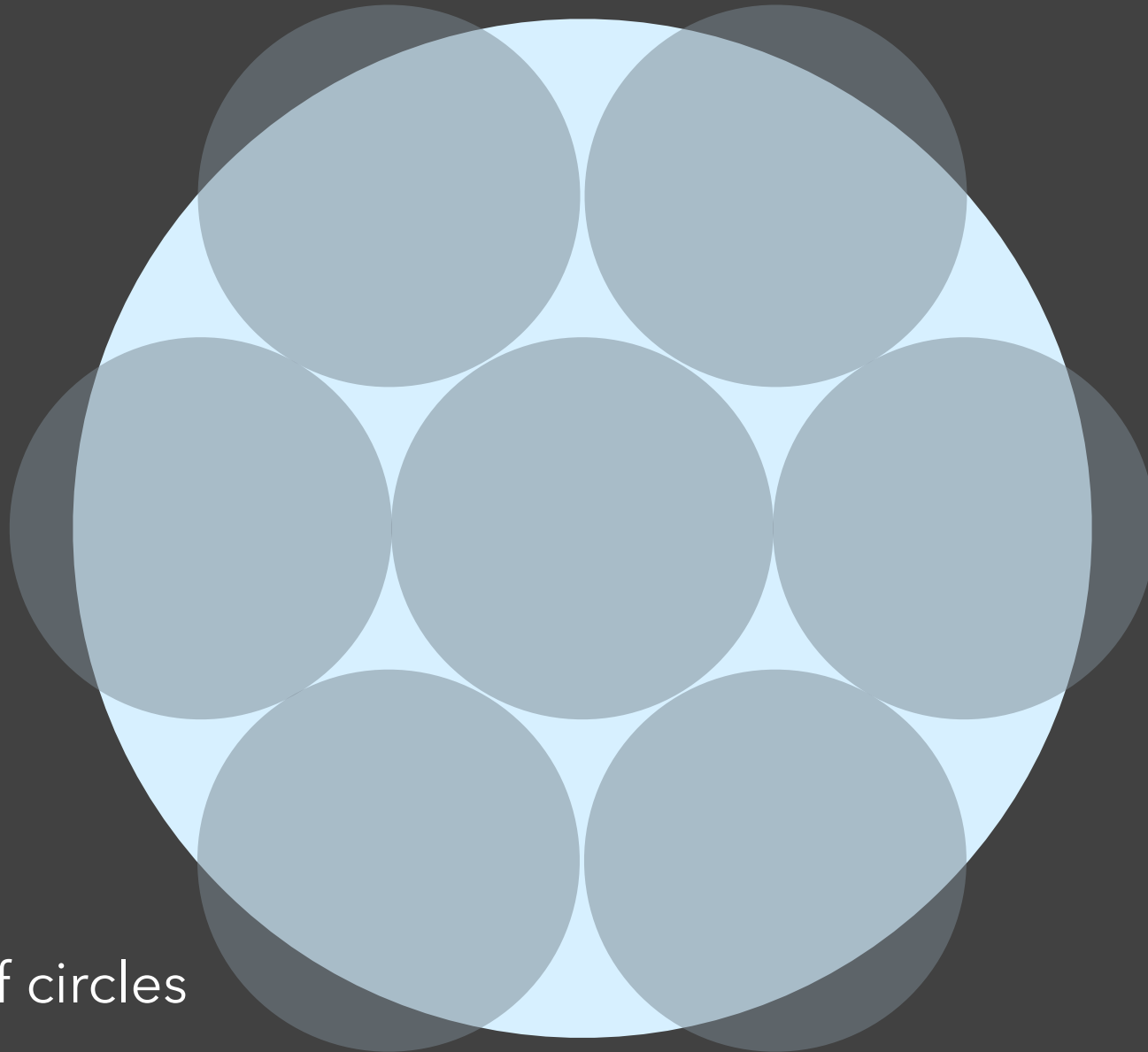
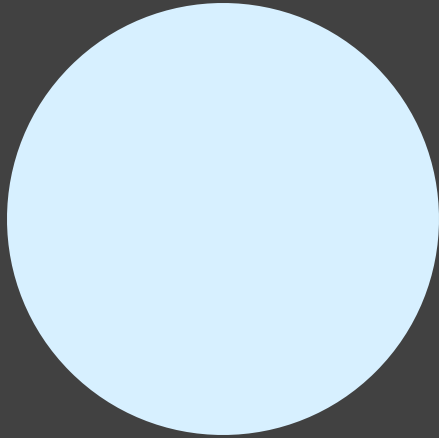

Compare area of circles

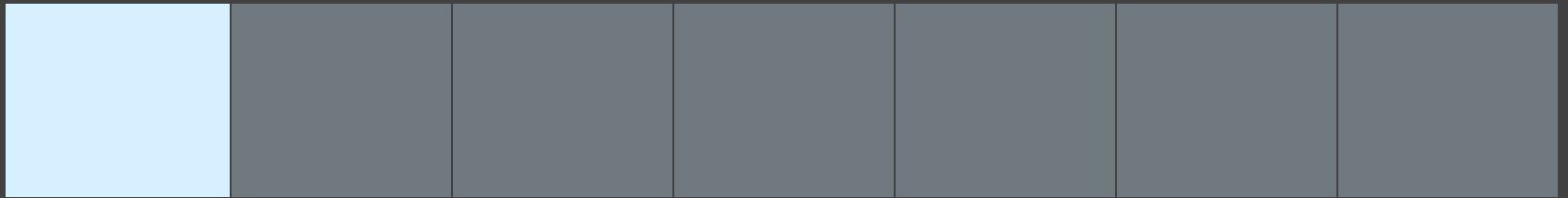
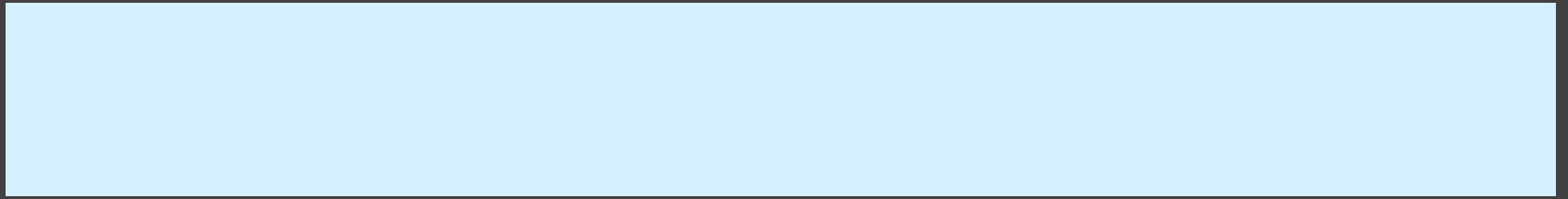

Compare length of bars

Steven's Power Law

Exponent
(Empirically Determined)

$$S = I^p$$

↑ ↑
Perceived Physical
Sensation Intensity

Predicts bias, not necessarily accuracy!

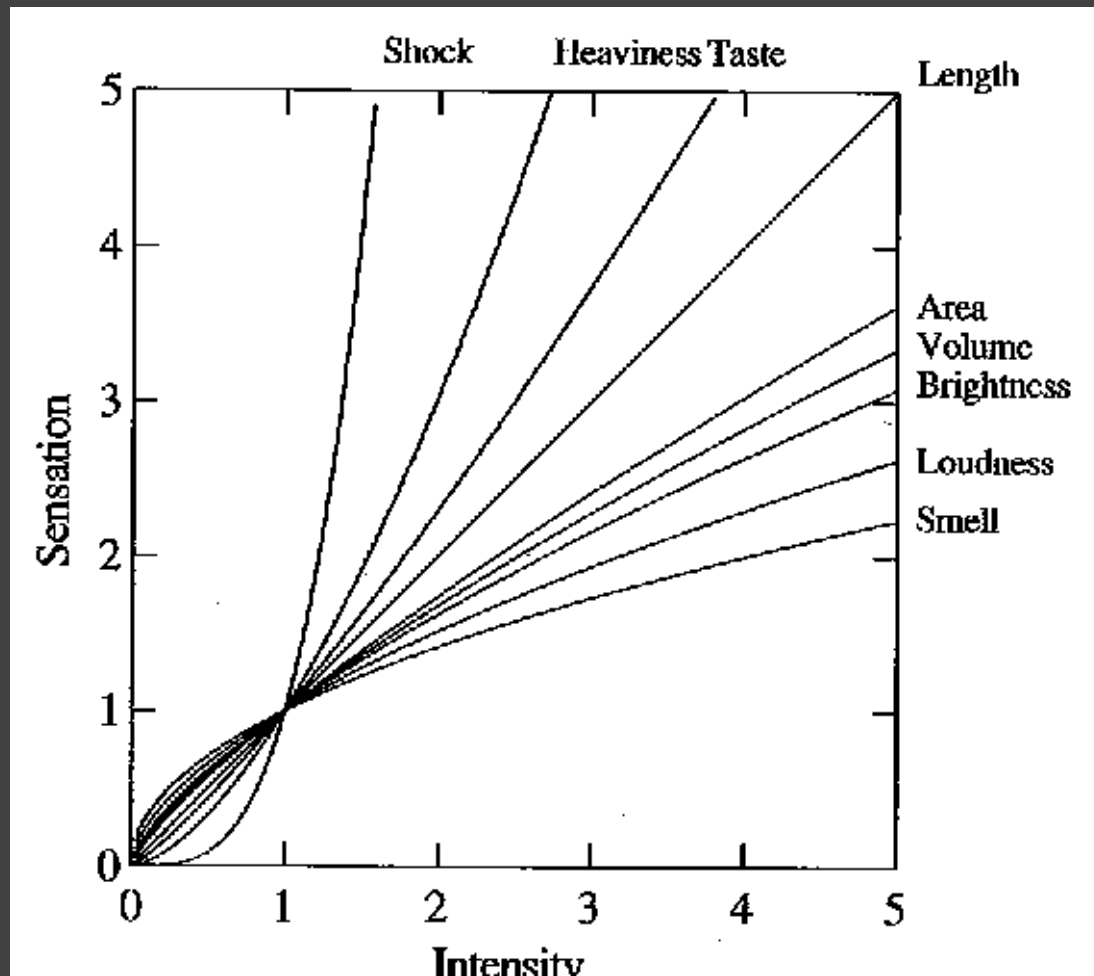

[Graph from Wilkinson 99, based on Stevens 61]

Exponents of Power Law

Sensation	Exponent
Loudness	0.6
Brightness	0.33
Smell	0.55 (Coffee) - 0.6 (Heptane)
Taste	0.6 (Saccharine) -1.3 (Salt)
Temperature	1.0 (Cold) – 1.6 (Warm)
Vibration	0.6 (250 Hz) – 0.95 (60 Hz)
Duration	1.1
Pressure	1.1
Heaviness	1.45
Electric Shock	3.5

[Psychophysics of Sensory Function, Stevens 61]

Apparent Magnitude Scaling

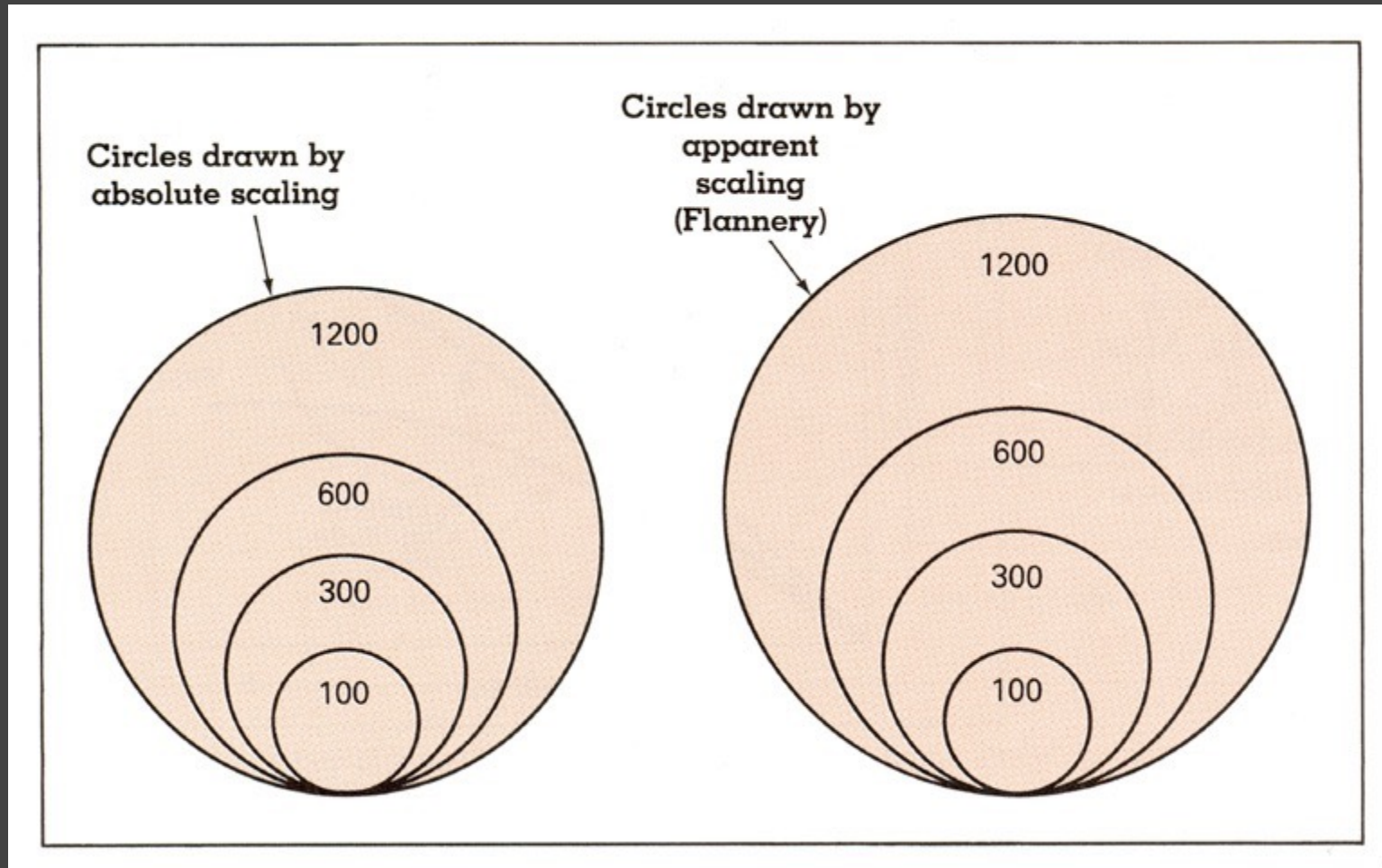

[Cartography: Thematic Map Design, Figure 8.6, p. 170, Dent, 96]

$$S = 0.98A^{0.87} \text{ [from Flannery 71]}$$

Graduated Sphere Map

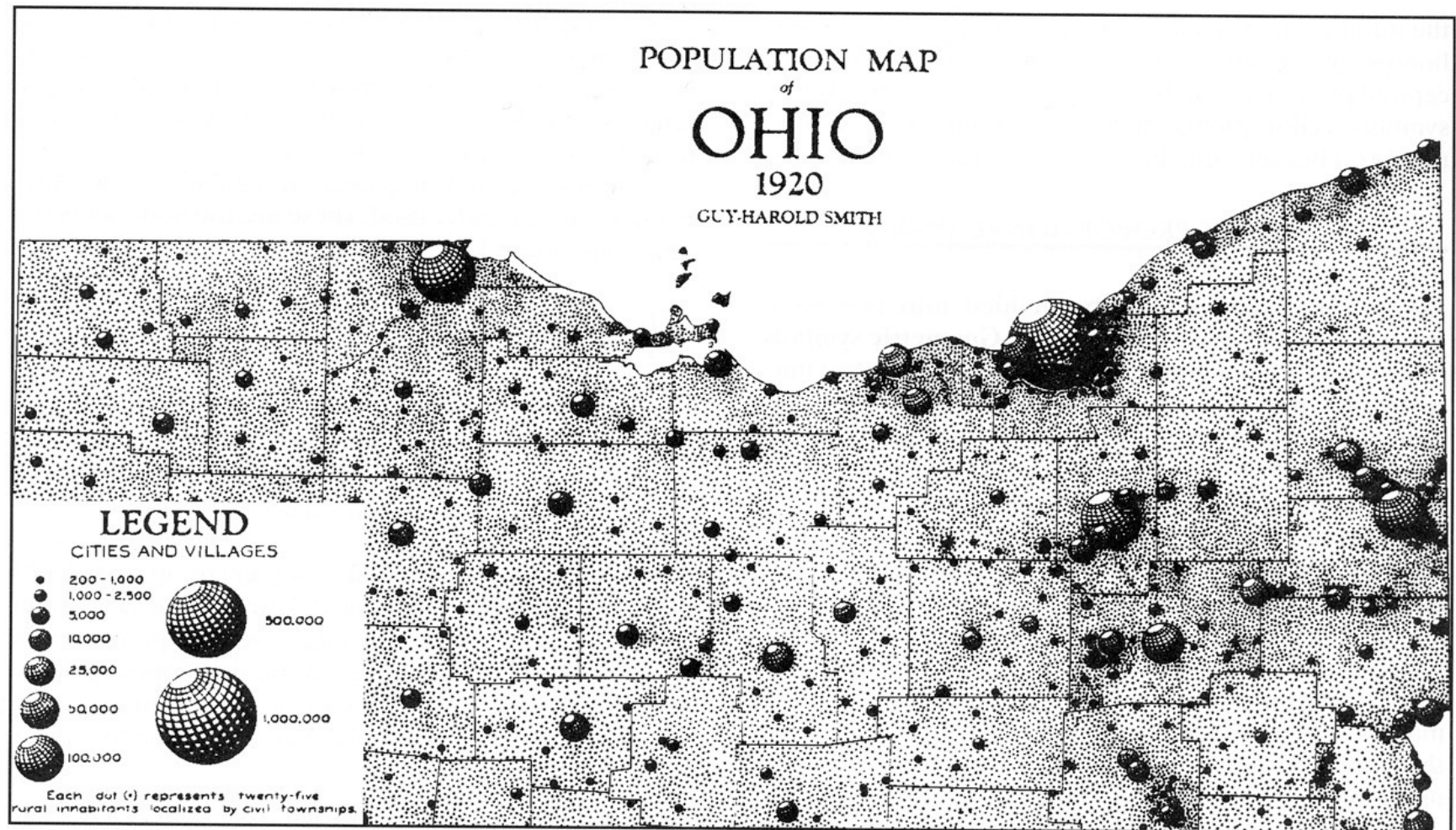

FIGURE 7.4. An eye-catching map created using three-dimensional geometric symbols. (After Smith, 1928. First published in *The Geographical Review*, 18(3), plate 4. Reprinted with permission of the American Geographical Society.)

Steven's Power Law

Exponent
(Empirically Determined)

$$S = I^p$$

↑ ↑
Perceived Physical
Sensation Intensity

Predicts bias, not necessarily accuracy!

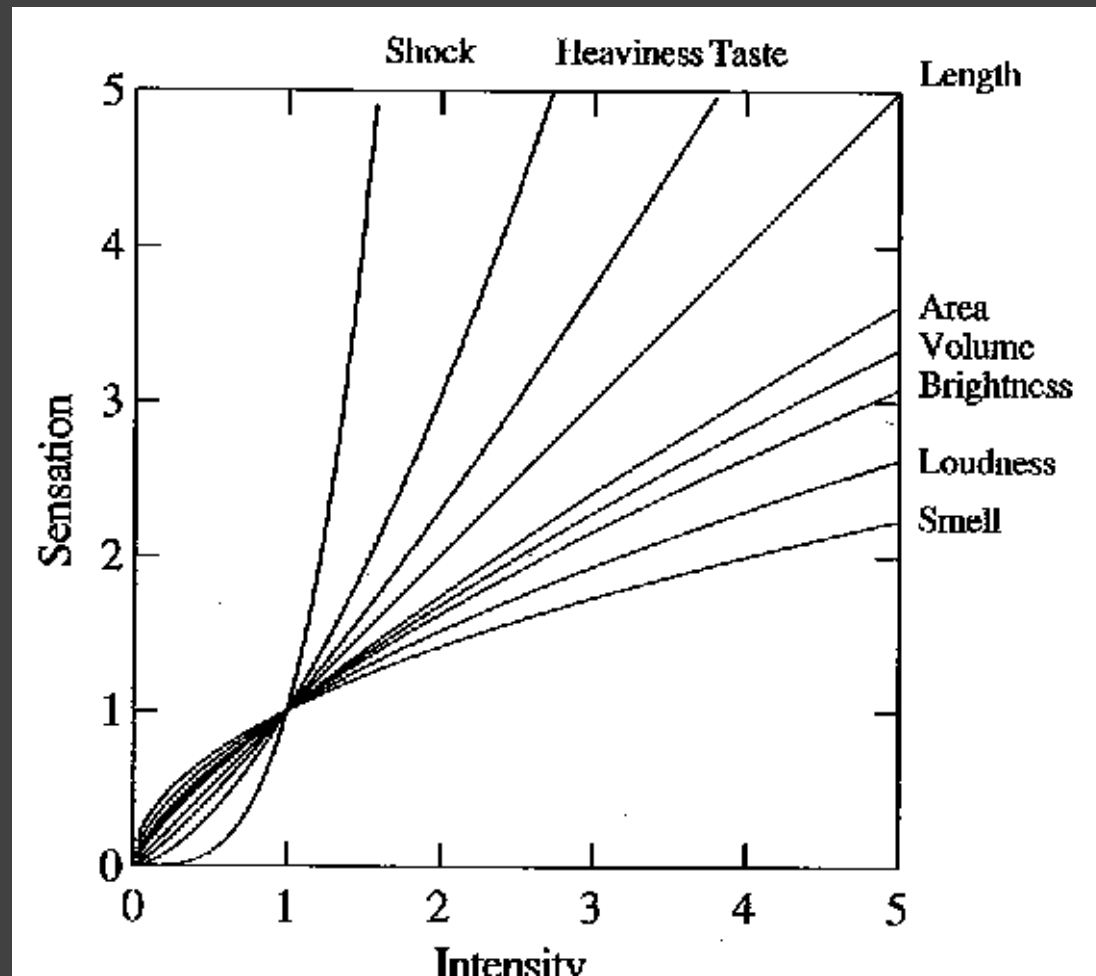

[Graph from Wilkinson 99, based on Stevens 61]

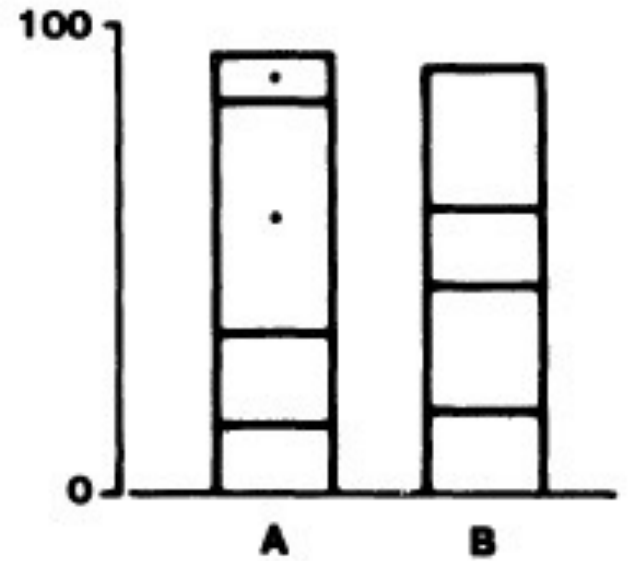
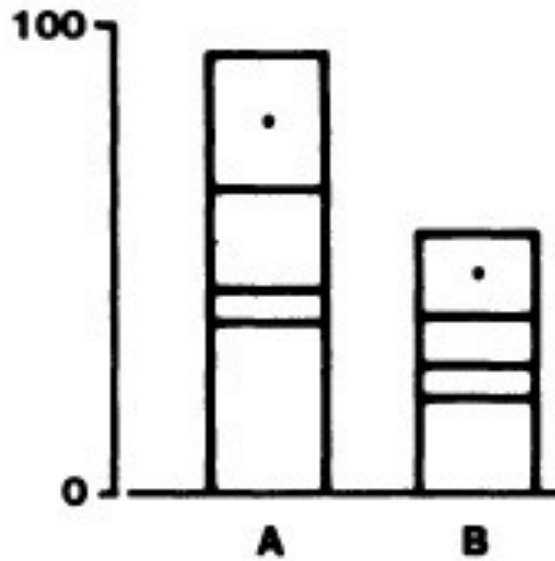
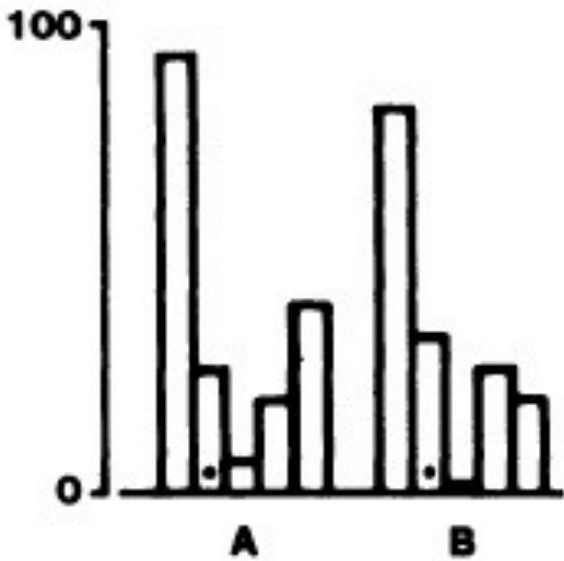

Graphical Perception [Cleveland & McGill 84]

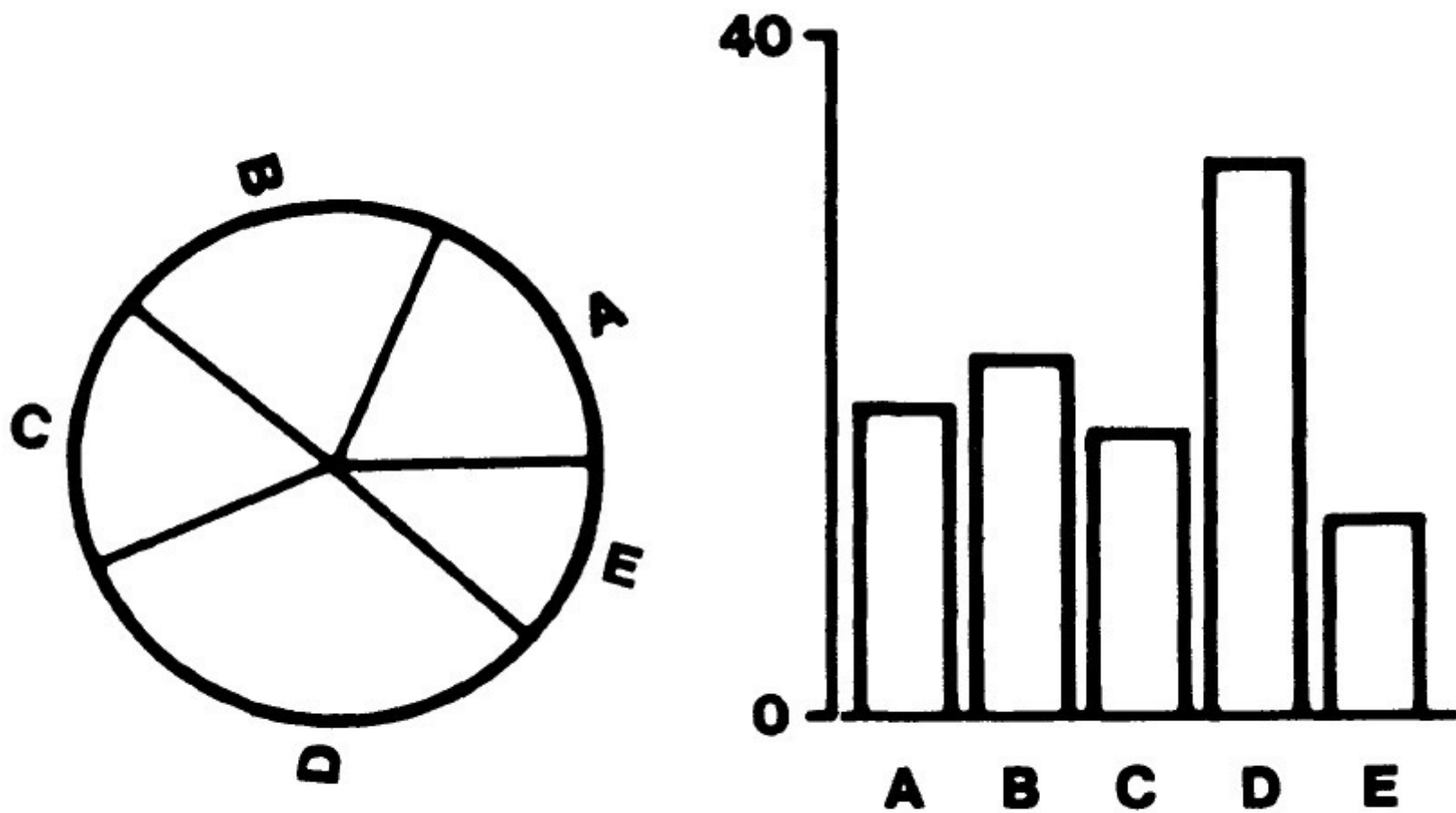
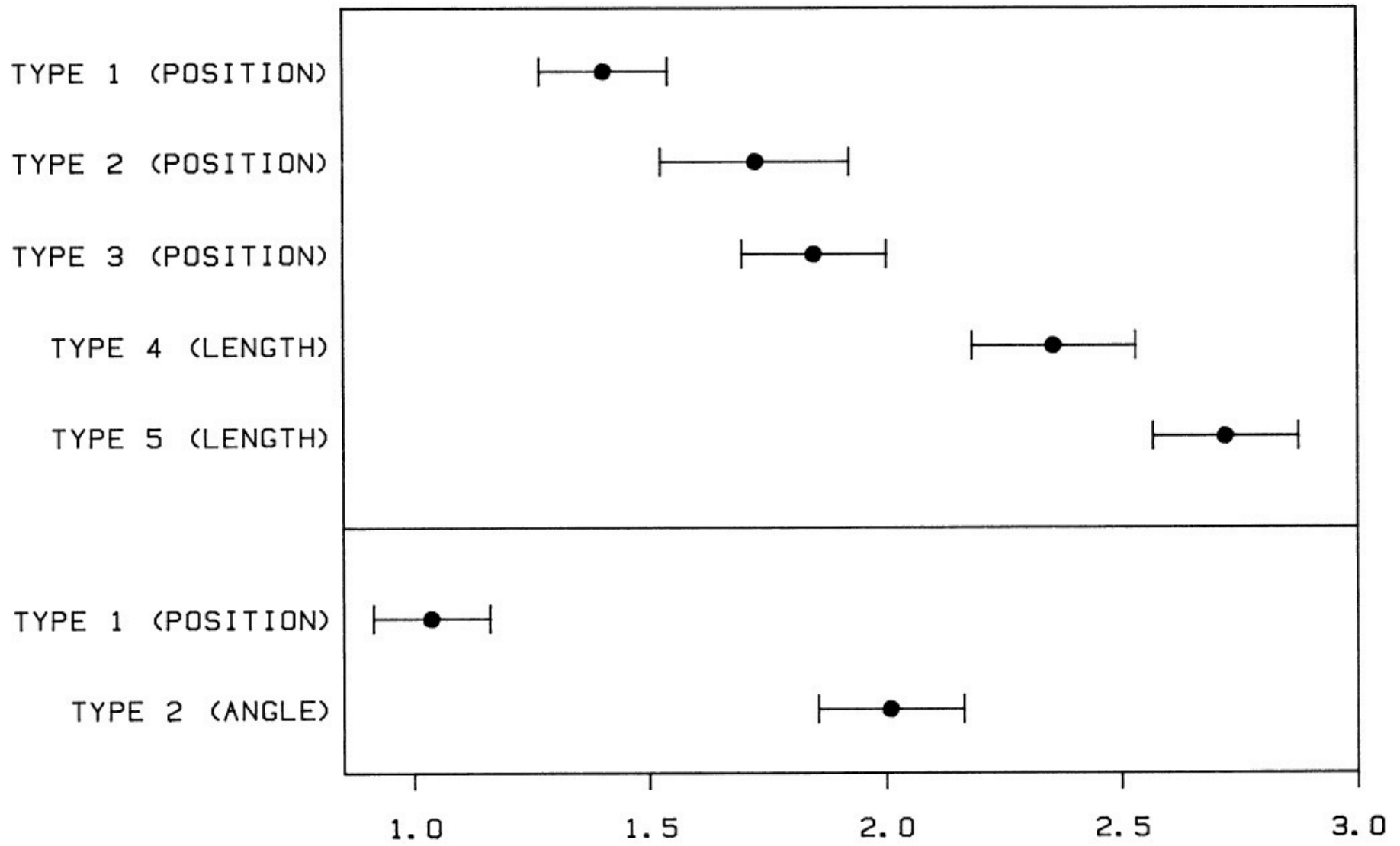

Figure 3. Graphs from position-angle experiment.



Cleveland & McGill, '84

LOG BASE 2 (ABSOLUTE ERROR + .125)

Figure 16. Log absolute error means and 95% confidence intervals for judgment types in position-length experiment (top) and position-angle experiment (bottom).

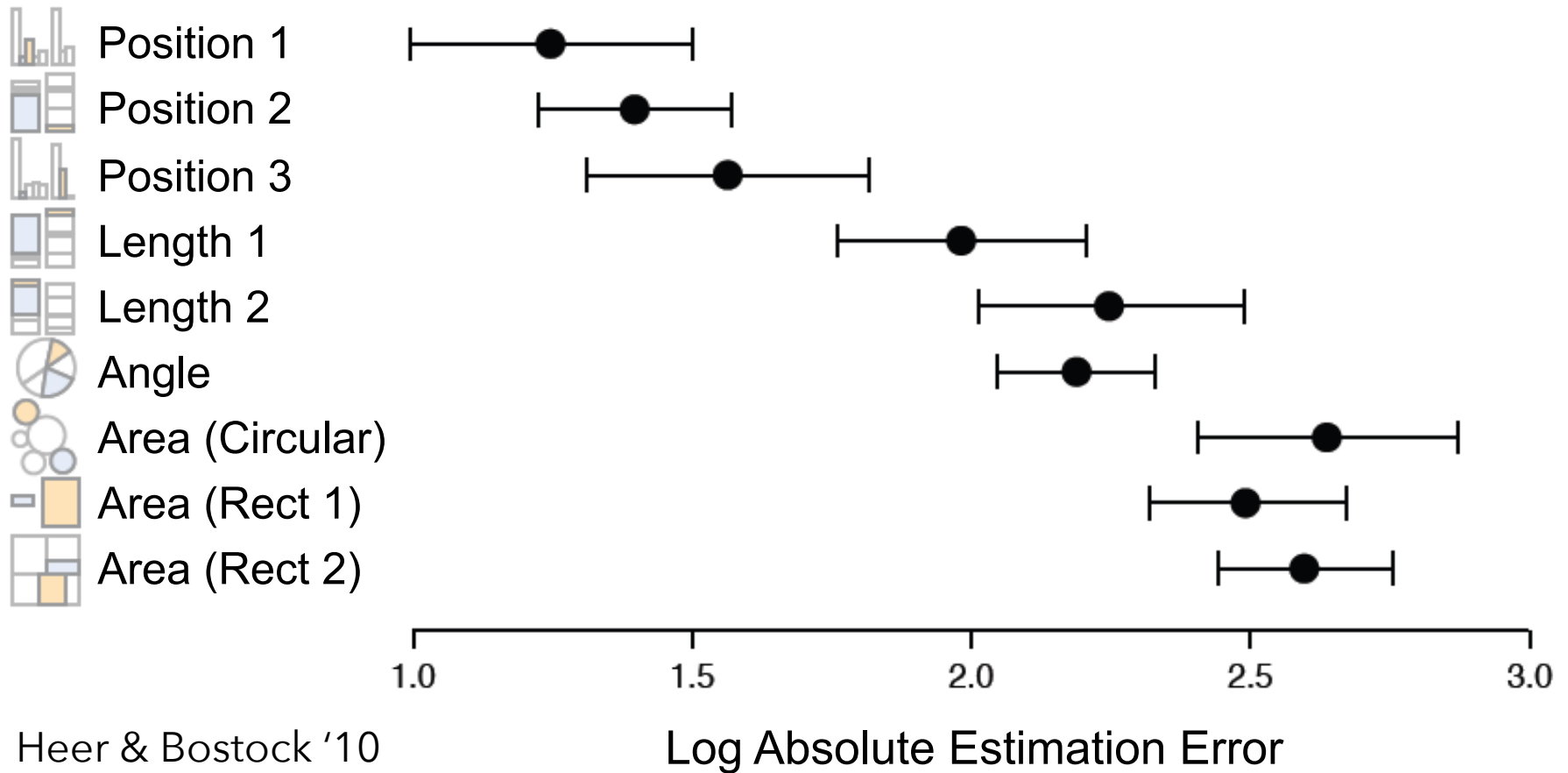

Graphical Perception Experiments

Empirical estimates of encoding effectiveness

Relative Magnitude Comparison

Most accurate



Least accurate



Position (common) scale



Position (non-aligned) scale



Length



Slope



Angle



Area



Volume



Color hue-saturation-density

Effectiveness Rankings [Mackinlay 86]

QUANTITATIVE

Position
Length
Angle
Slope
Area (Size)
Volume
Density (Value)
Color Sat
Color Hue
Texture
Connection
Containment
Shape

ORDINAL

Position
Density (Value)
Color Sat
Color Hue
Texture
Connection
Containment
Length
Angle
Slope
Area (Size)
Volume
Shape

NOMINAL

Position
Color Hue
Texture
Connection
Containment
Density (Value)
Color Sat
Shape
Length
Angle
Slope
Area
Volume

Administrivia

A2: Exploratory Data Analysis

Use visualization software to form & answer questions

First steps:

Step 1: Pick domain & data

Step 2: Pose questions

Step 3: Profile the data

Iterate as needed

Create visualizations

Interact with data

Refine your questions

Make a notebook

Keep record of your analysis

Prepare a final graphic and caption

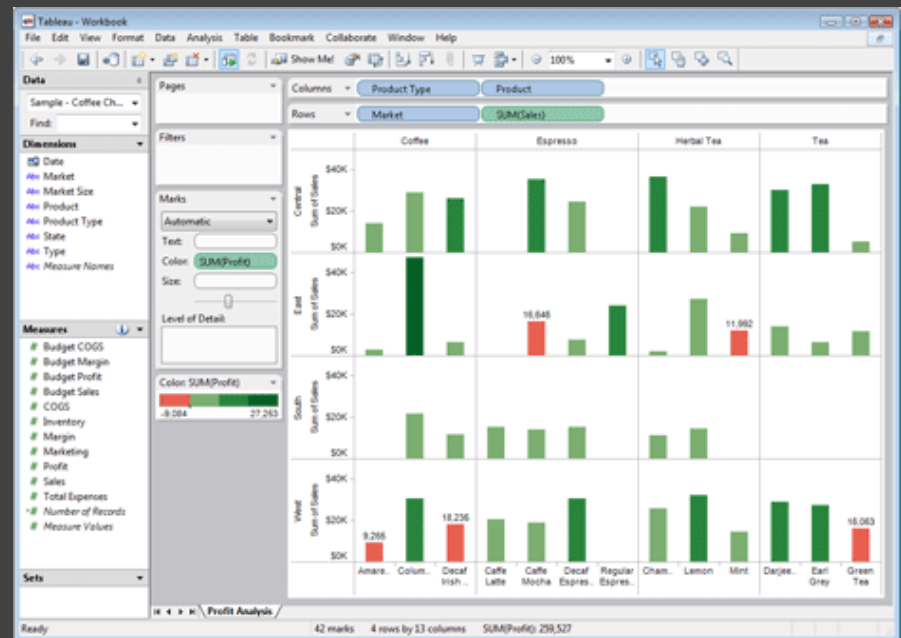

~~Due by 5:00pm
Friday, April 15~~

A2: Exploratory Data Analysis

Use visualization software to form & answer questions

First steps:

Step 1: Pick domain & data

Step 2: Pose questions

Step 3: Profile the data

Iterate as needed

Create visualizations

Interact with data

Refine your questions

Make a notebook

Keep record of your analysis

Prepare a final graphic and caption

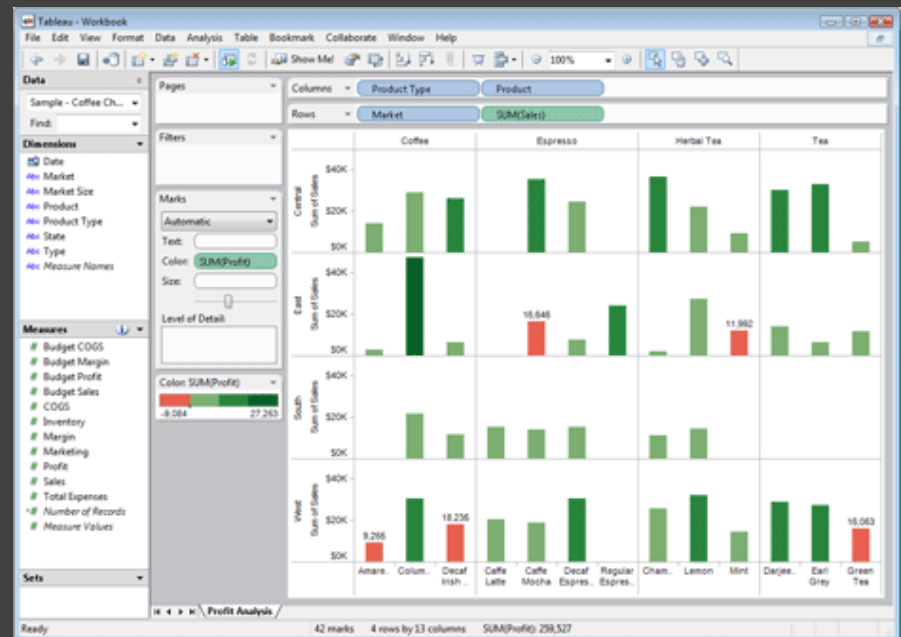

Due by 5:00pm

Monday, April 18

D3.js Tutorial

Date: **Tuesday, April 19**

Time: **3pm to 4:20pm**

Location: **PAA, Room 114A**

D3.js is a popular JavaScript visualization library, valuable for A3 and your Final Project...

Pre-Attentive Processing

How Many 3's?

1281768756138976546984506985604982826762
9809858458224509856458945098450980943585
9091030209905959595772564675050678904567
8845789809821677654876364908560912949686

[based on a slide from J. Stasko]

How Many 3's?

1281768756138976546984506985604982826762
9809858458224509856458945098450980943585
9091030209905959595772564675050678904567
8845789809821677654876364908560912949686

[based on a slide from J. Stasko]

Visual Pop-Out: Color

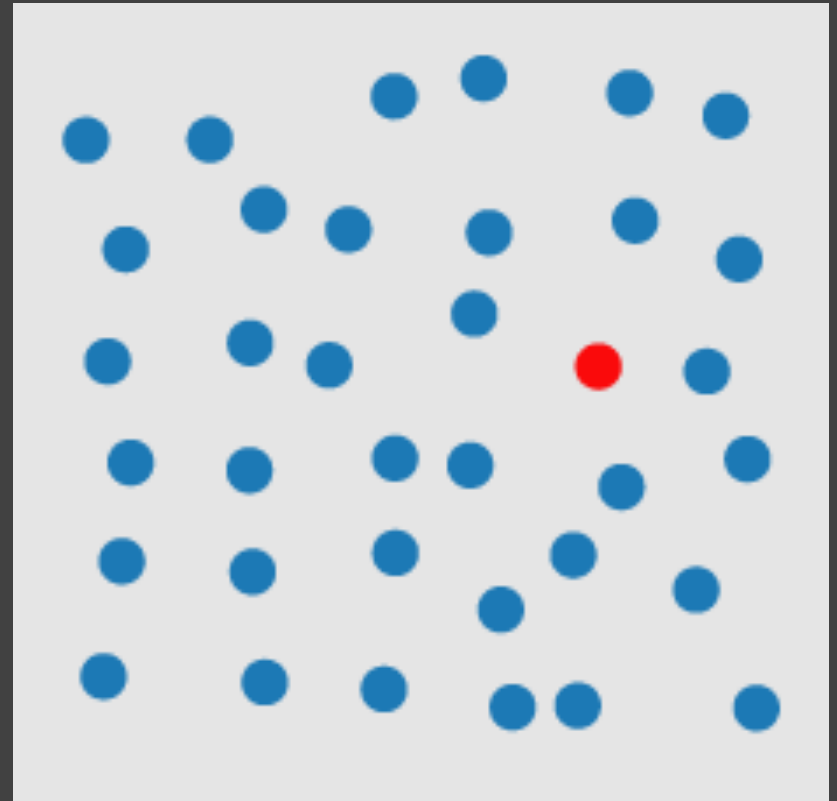
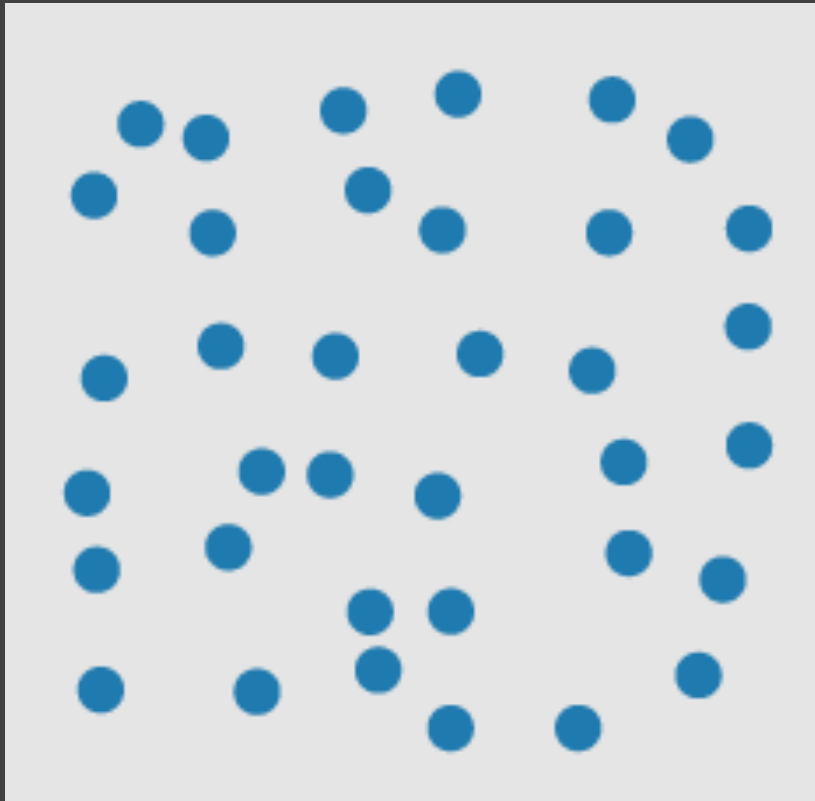

<http://www.csc.ncsu.edu/faculty/healey/PP/index.html>

Visual Pop-Out: Shape

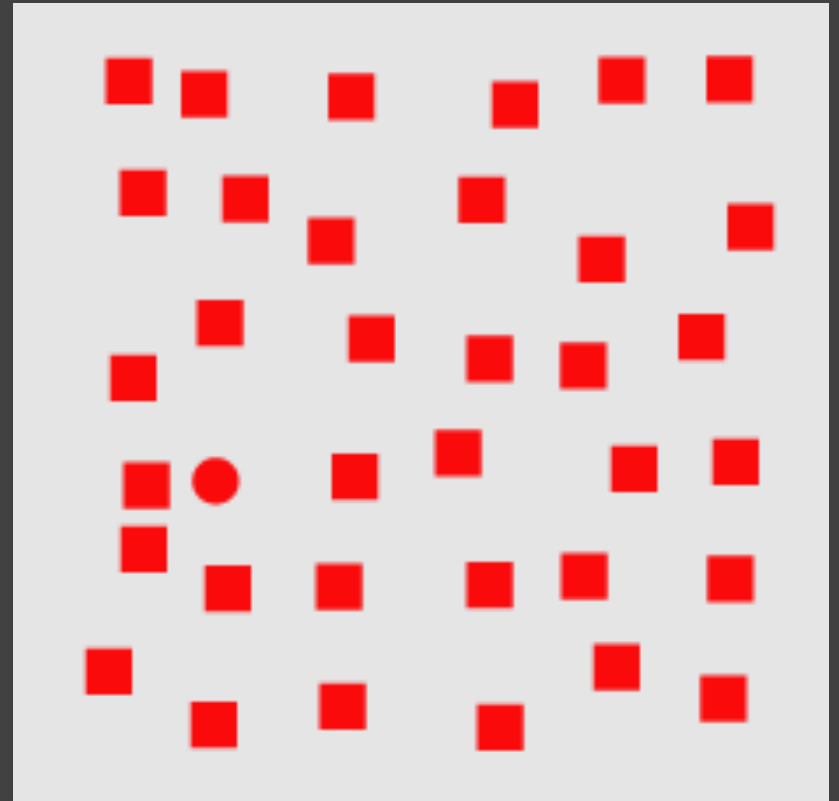
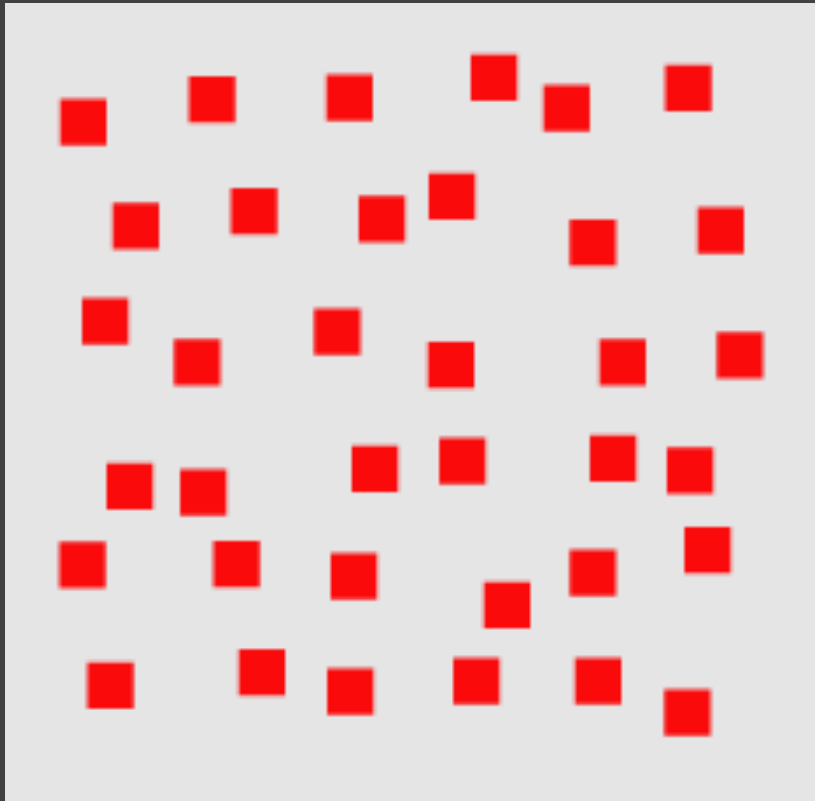

<http://www.csc.ncsu.edu/faculty/healey/PP/index.html>

Feature Conjunctions

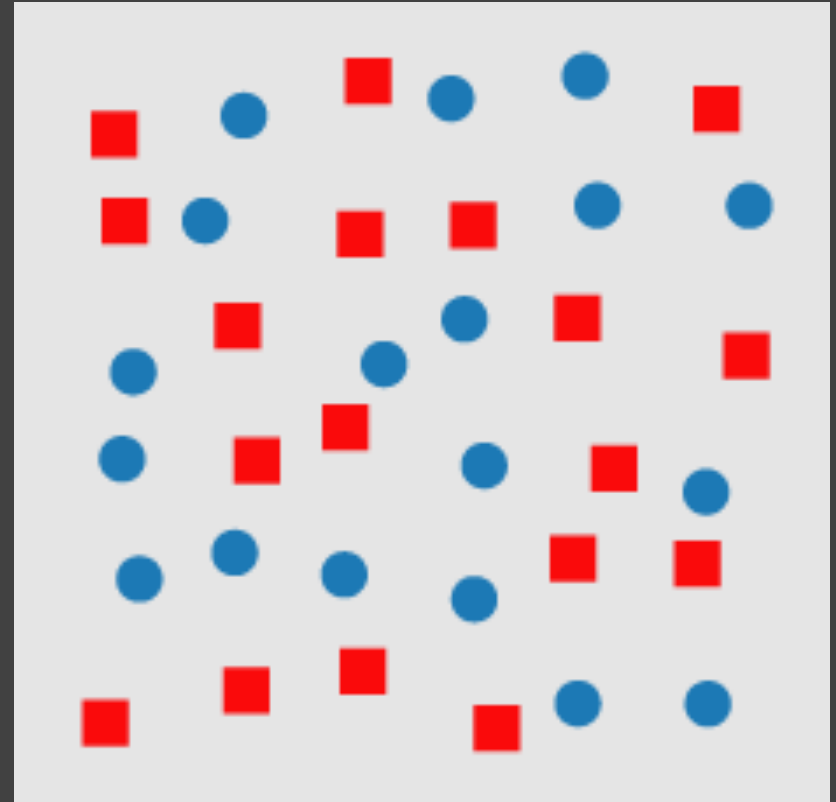
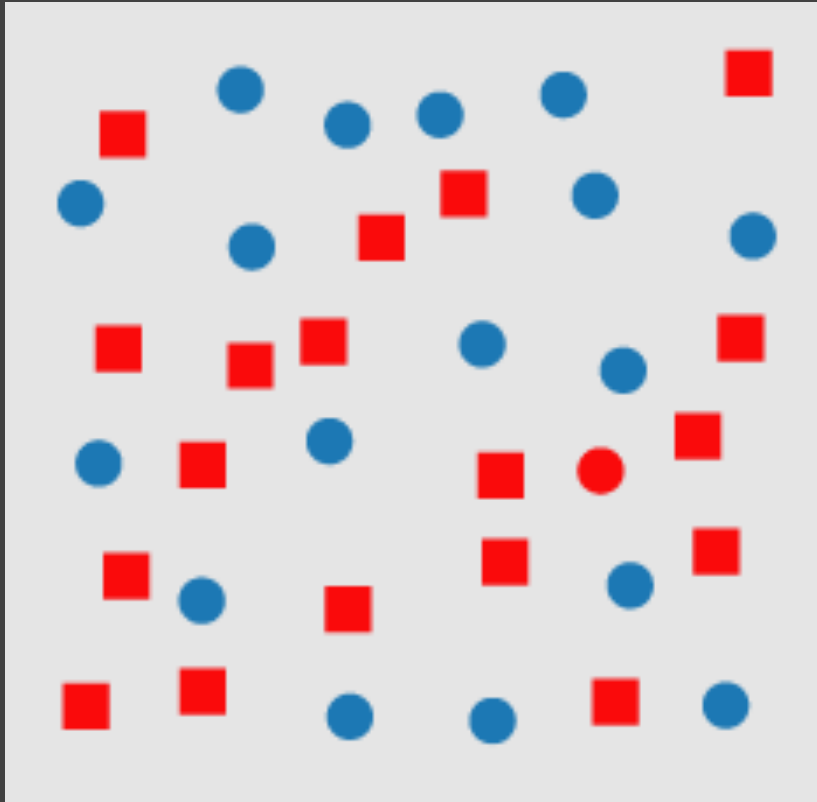

Pre-Attentive Features

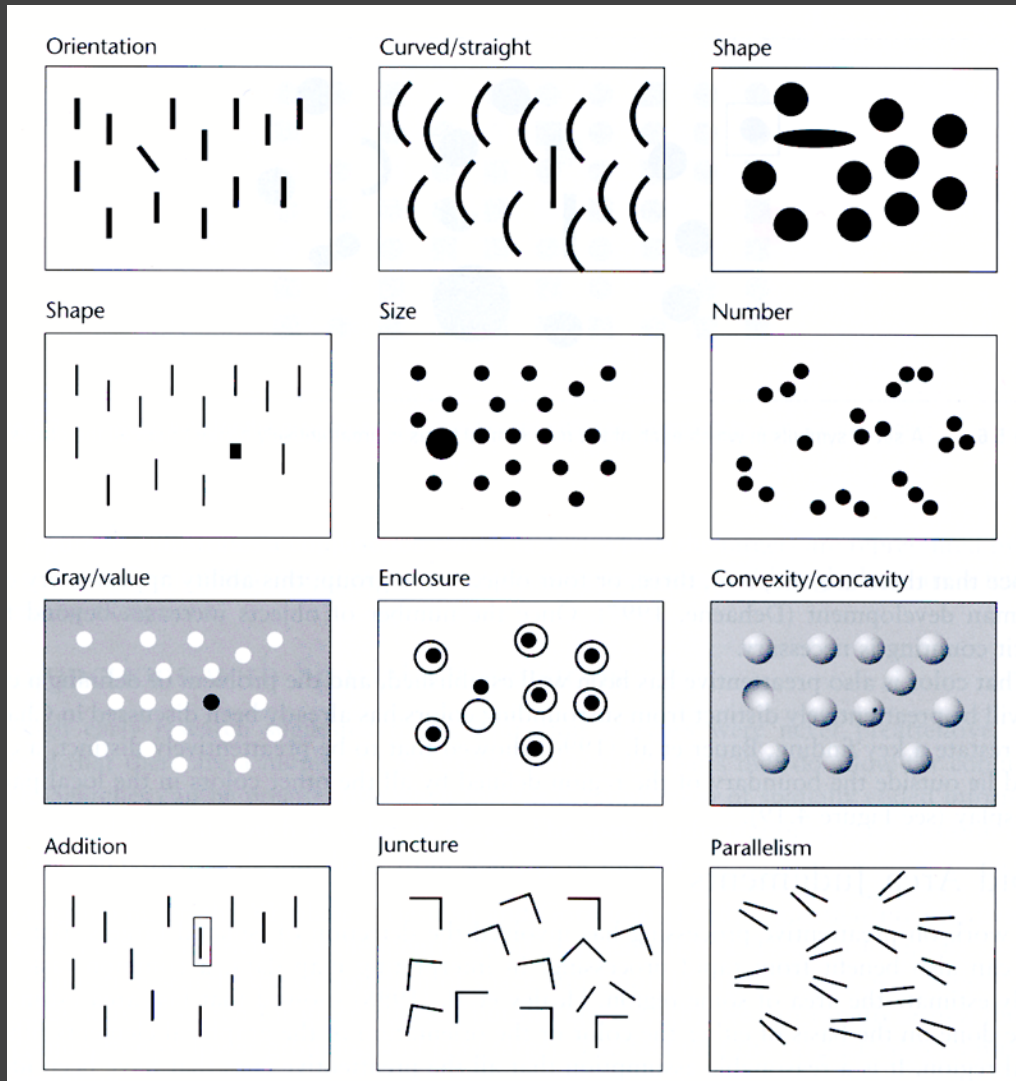

[Information Visualization.
Figure 5.5 Ware 04]

More Pre-Attentive Features

Line (blob) orientation	Julesz & Bergen [1983]; Wolfe et al. [1992]
Length	Triesman & Gormican [1988]
Width	Julesz [1985]
Size	Triesman & Gelade [1980]
Curvature	Triesman & Gormican [1988]
Number	Julesz [1985]; Trick & Pylyshyn [1994]
Terminators	Julesz & Bergen [1983]
Intersection	Julesz & Bergen [1983]
Closure	Enns [1986]; Triesman & Souther [1985]
Colour (hue)	Nagy & Sanchez [1990, 1992]; D'Zmura [1991]; Kawai et al. [1995]; Bauer et al. [1996]
Intensity	Beck et al. [1983]; Triesman & Gormican [1988]
Flicker	Julesz [1971]
Direction of motion	Nakayama & Silverman [1986]; Driver & McLeod [1992]
Binocular lustre	Wolfe & Franzel [1988]
Stereoscopic depth	Nakayama & Silverman [1986]
3-D depth cues	Enns [1990]
Lighting direction	Enns [1990]

Pre-Attentive Conjunctions

Spatial conjunctions are often pre-attentive

Motion and 3D disparity

Motion and color

Motion and shape

3D disparity and color

3D disparity and shape

Most conjunctions are not pre-attentive

Feature Integration Theory

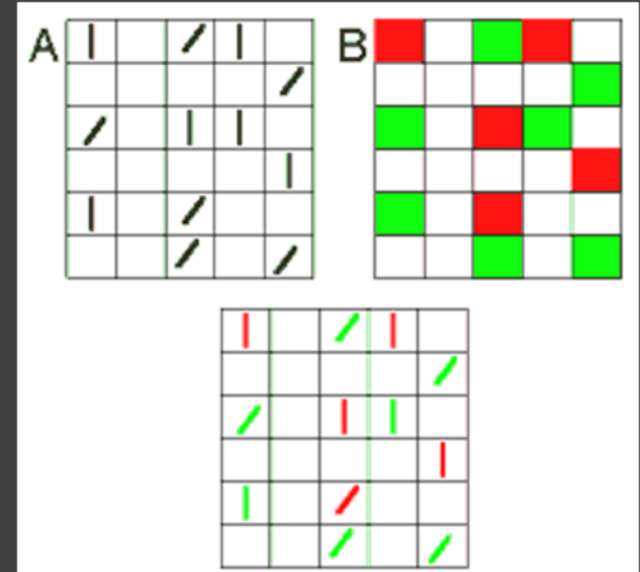
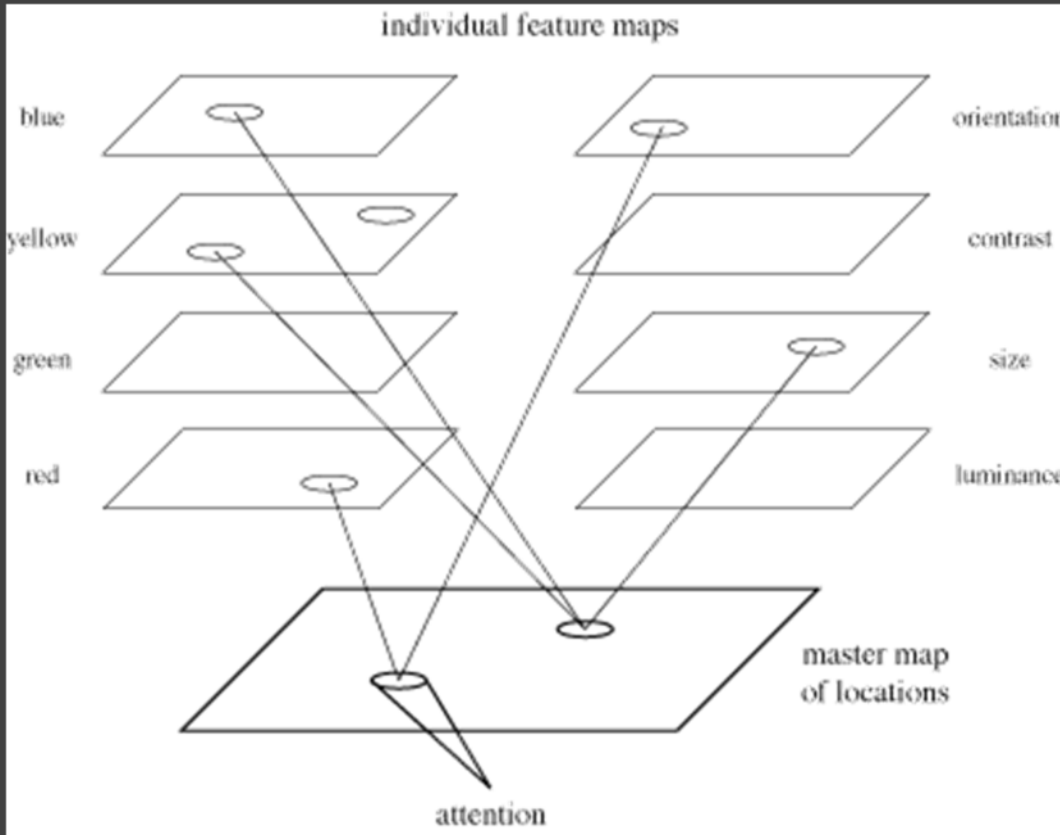

Feature maps for orientation & color [Green]

Treisman's feature integration model [Healey 04]

Multiple Attributes

One-Dimensional: Lightness



White



White



Black



White



Black



White



Black



Black



White



White

One-Dimensional: Shape



Square



Circle



Circle



Square



Circle



Circle



Circle



Square



Circle



Circle

Redundant: Shape & Lightness



Circle



Square



Square



Circle



Square



Circle



Square



Square



Square



Circle

Orthogonal: Shape & Lightness



Circle



Square



Square



Circle



Square

Speeded Classification

Redundancy Gain

Facilitation in reading one dimension when the other provides redundant information

Filtering Interference

Difficulty in ignoring one dimension while attending to the other

Speeded Classification

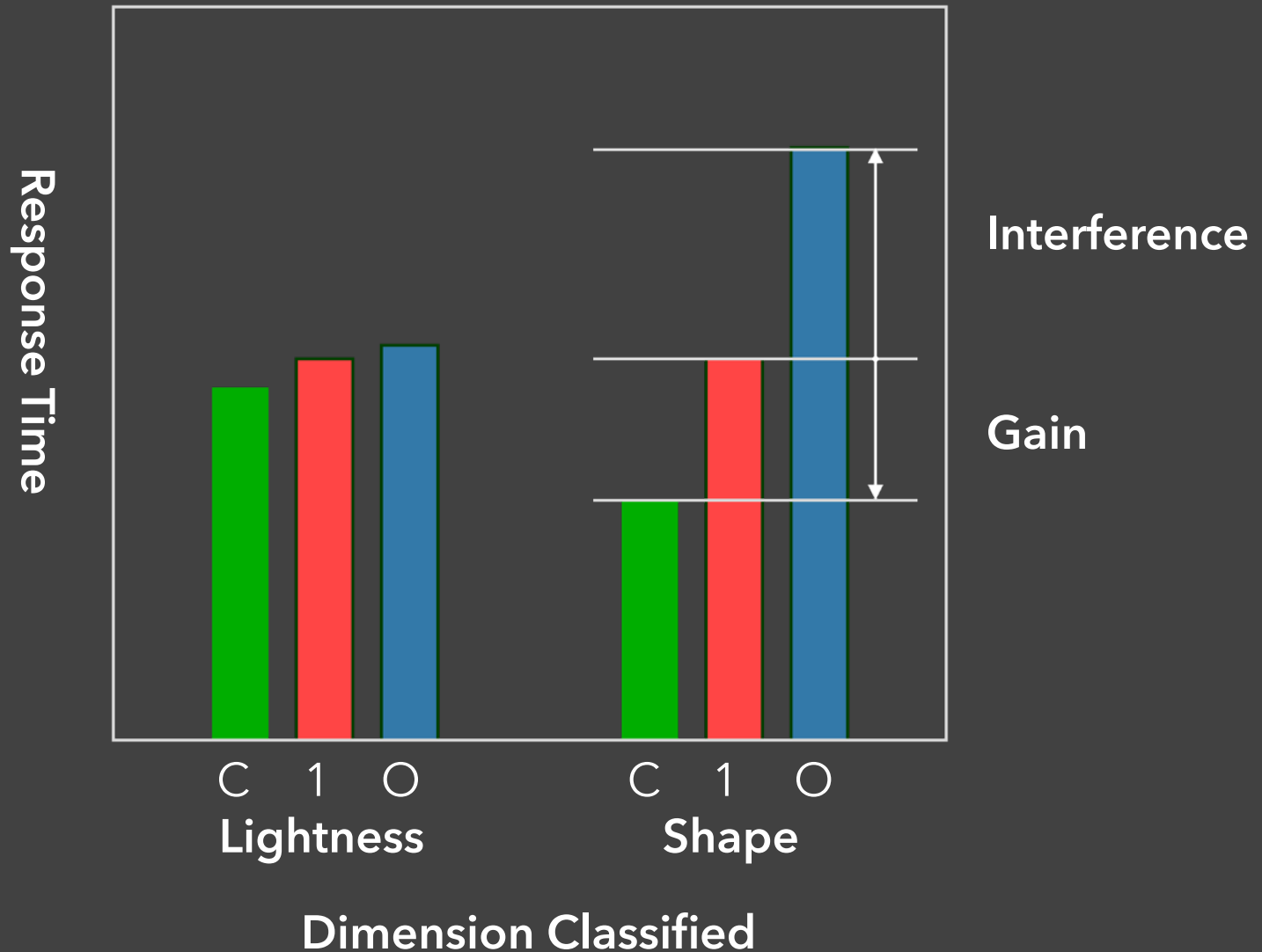

Types of Dimensions

Integral

Filtering interference and redundancy gain

Separable

No interference or gain

Asymmetric

One dim separable from other, not vice versa

Example: The Stroop effect – color naming is influenced by word identity, but word naming is not influenced by color

Size and Value

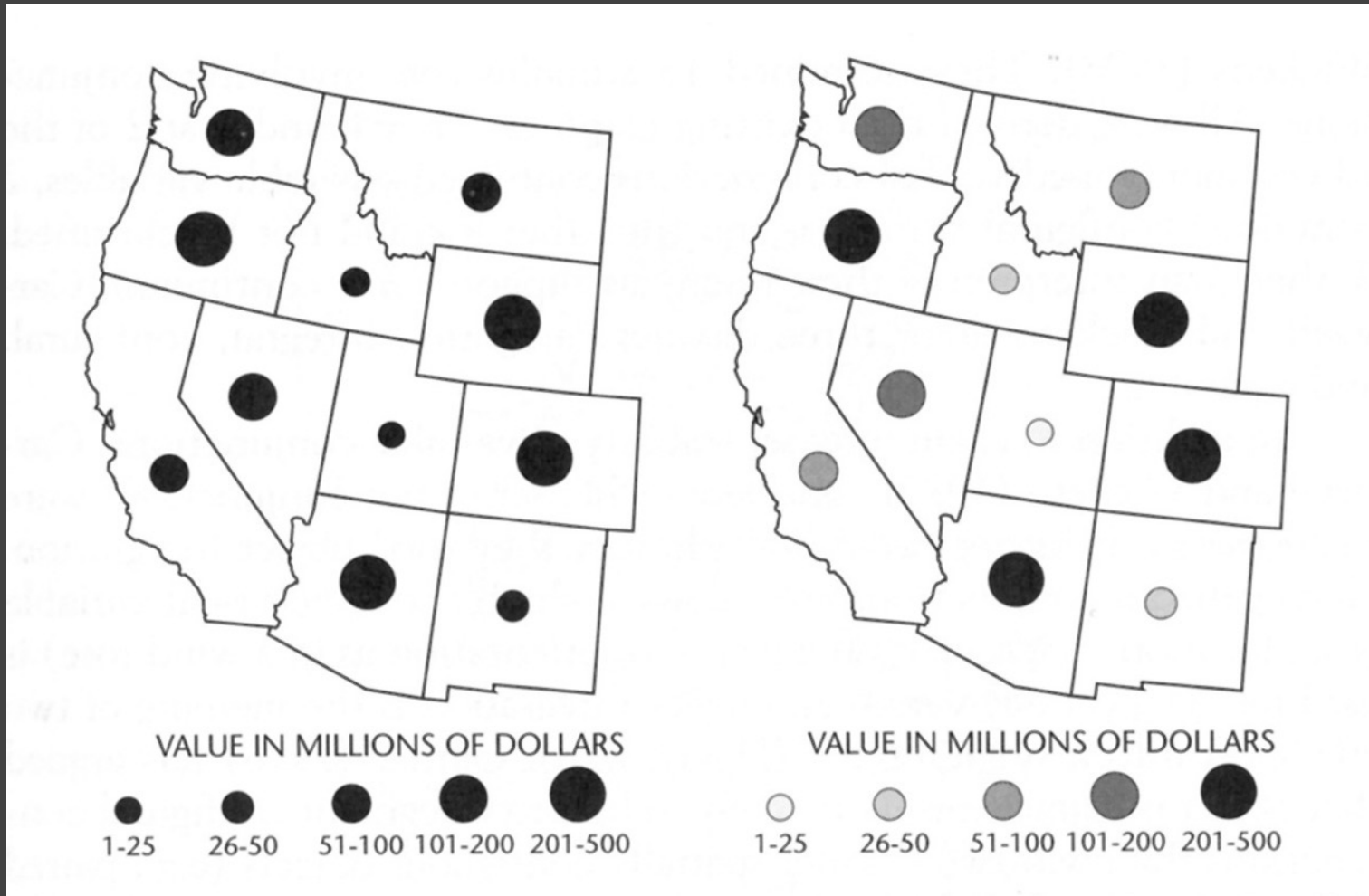

W. S. Dobson, Visual information processing and cartographic communication: The role of redundant stimulus dimensions, 1983 (reprinted in MacEachren, 1995)

Orientation & Size

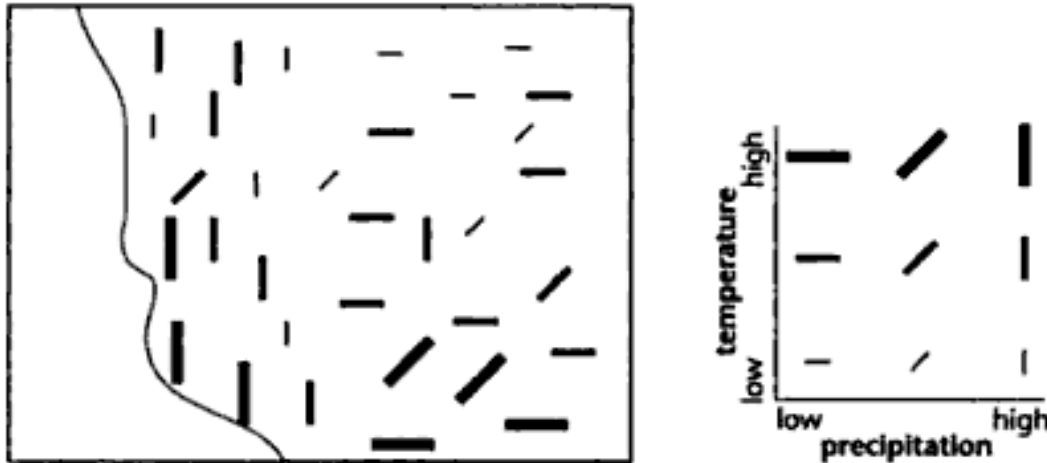

FIGURE 3.36. A map of temperature and precipitation using symbol size and orientation to represent data values on the two variables.

How well can you see temperature or precipitation?
Is there a correlation between the two?

Shape & Size

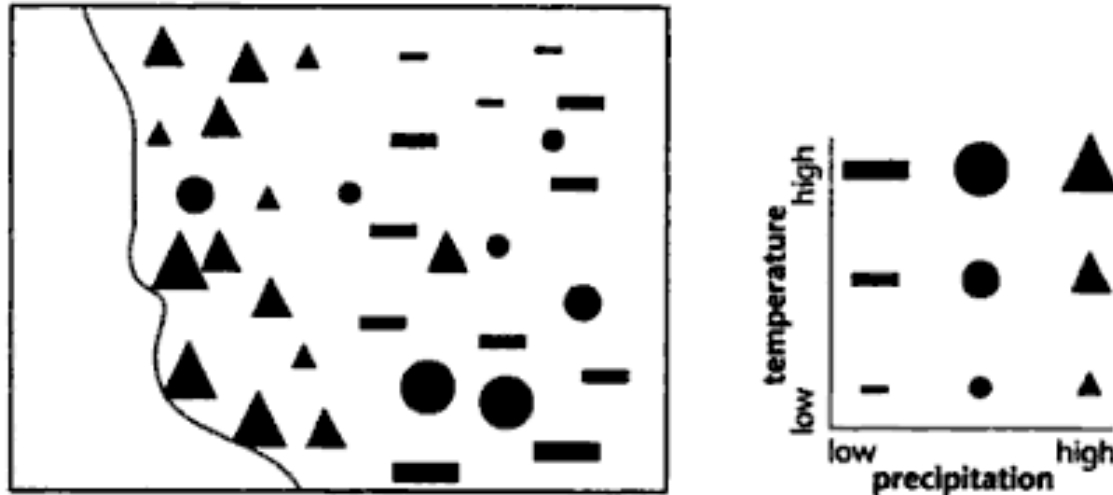

FIGURE 3.40. The bivariate temperature–precipitation map of Figure 3.36, this time using point symbols that vary in shape and size to represent the two quantities.

Easier to see one shape across multiple sizes than one size of across multiple shapes?

Length & Length

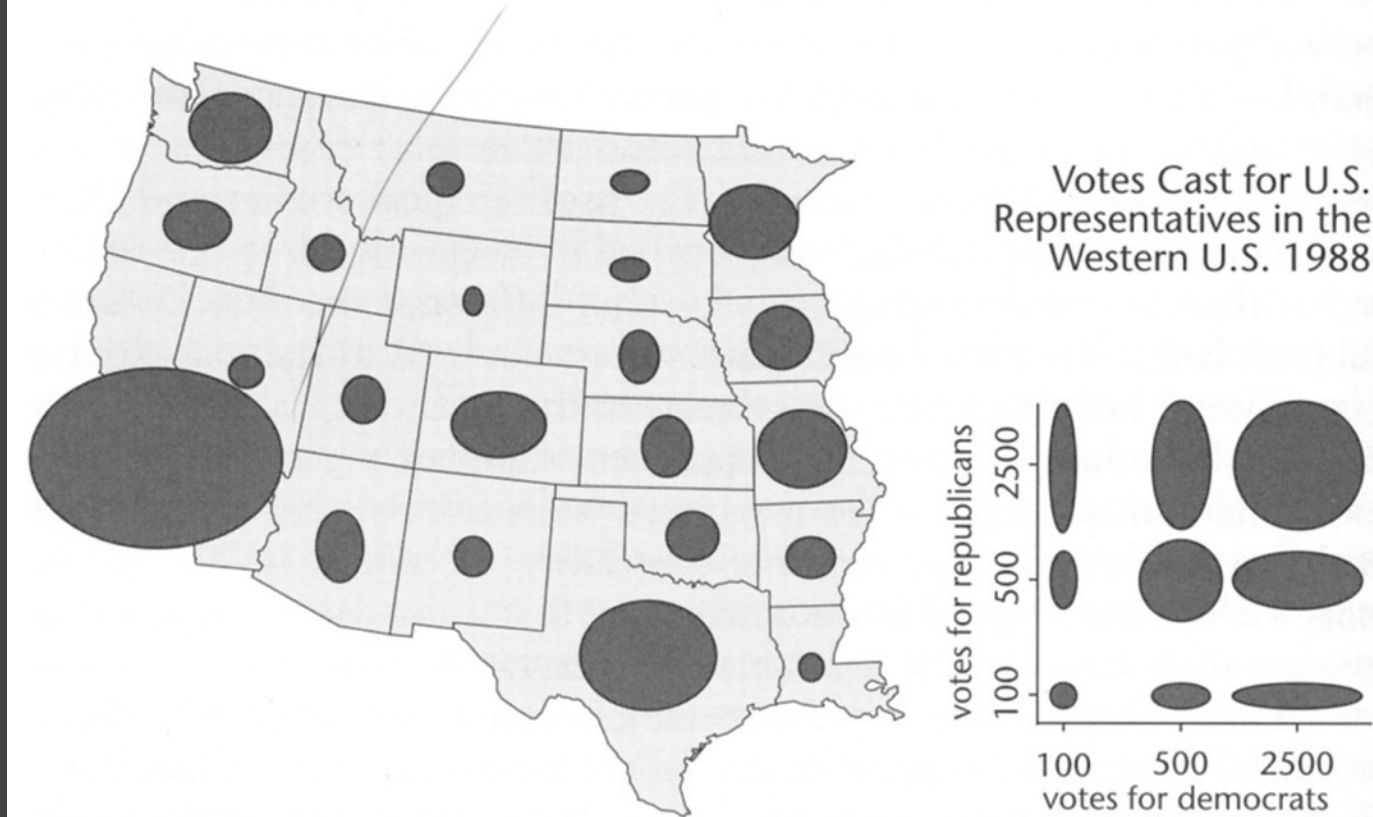

FIGURE 3.38. An example of the use of an ellipse as a map symbol in which the horizontal and vertical axes represent different (but presumably related) variables.

Angle & Angle

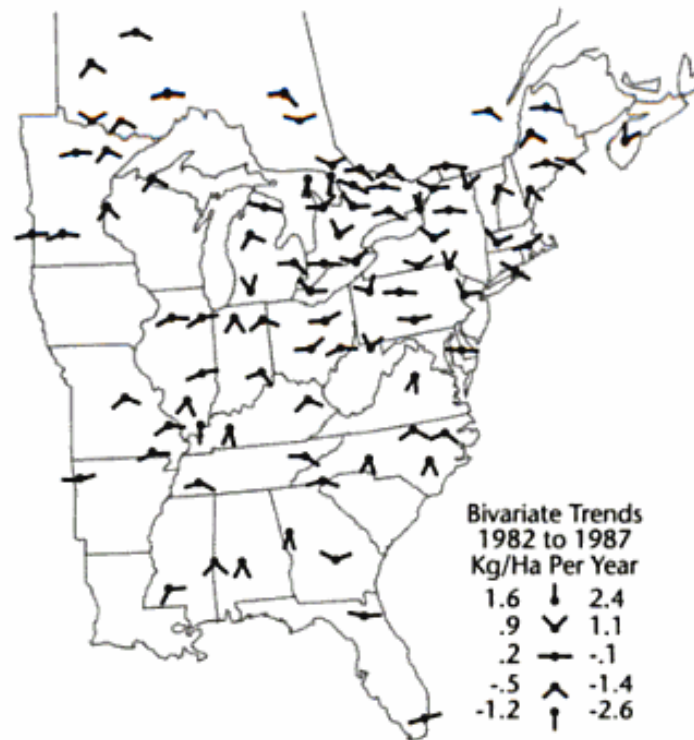
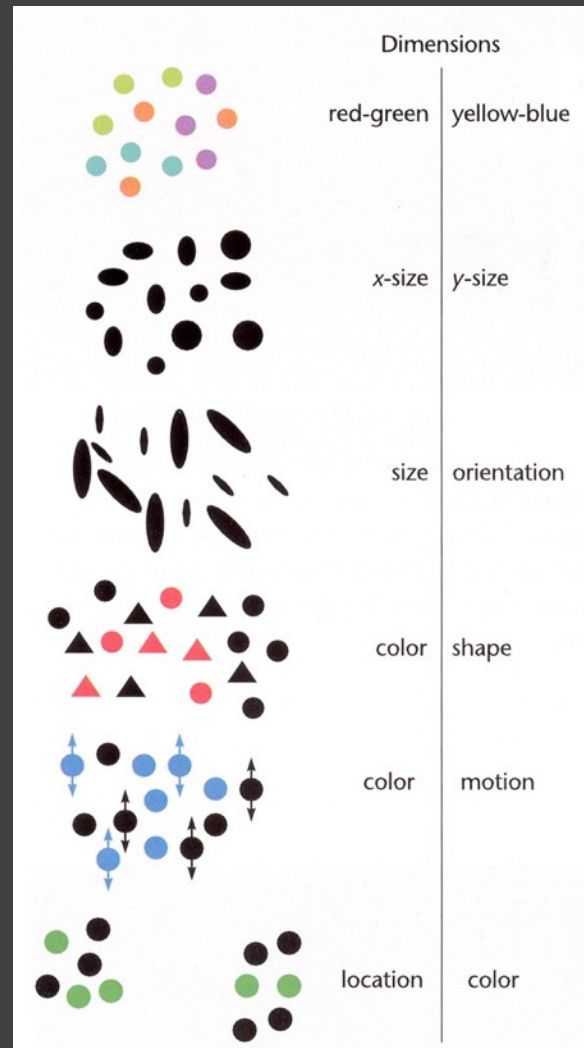

FIGURE 3.39. Bivariate map of NO₃ and SO₄ trends. The original Carr et al. version of this map used a wheel with eight spokes, rather than a simple dot, as the center of each glyph. When large enough, this added feature facilitates judgment of specific values. After Carr et al. (1992, Fig. 7a, p. 234). Adapted by permission of the American Congress on Surveying and Mapping.

Summary of Integral & Separable



Integral

Separable

[Figure 5.25,
Color Plate 10,
Ware 2000]

Set

Each card has **4 features**:

Color

Symbol

Number

Shading/Texture

A set consists of 3 cards in which each feature is the **SAME** or **DIFFERENT** on each card.

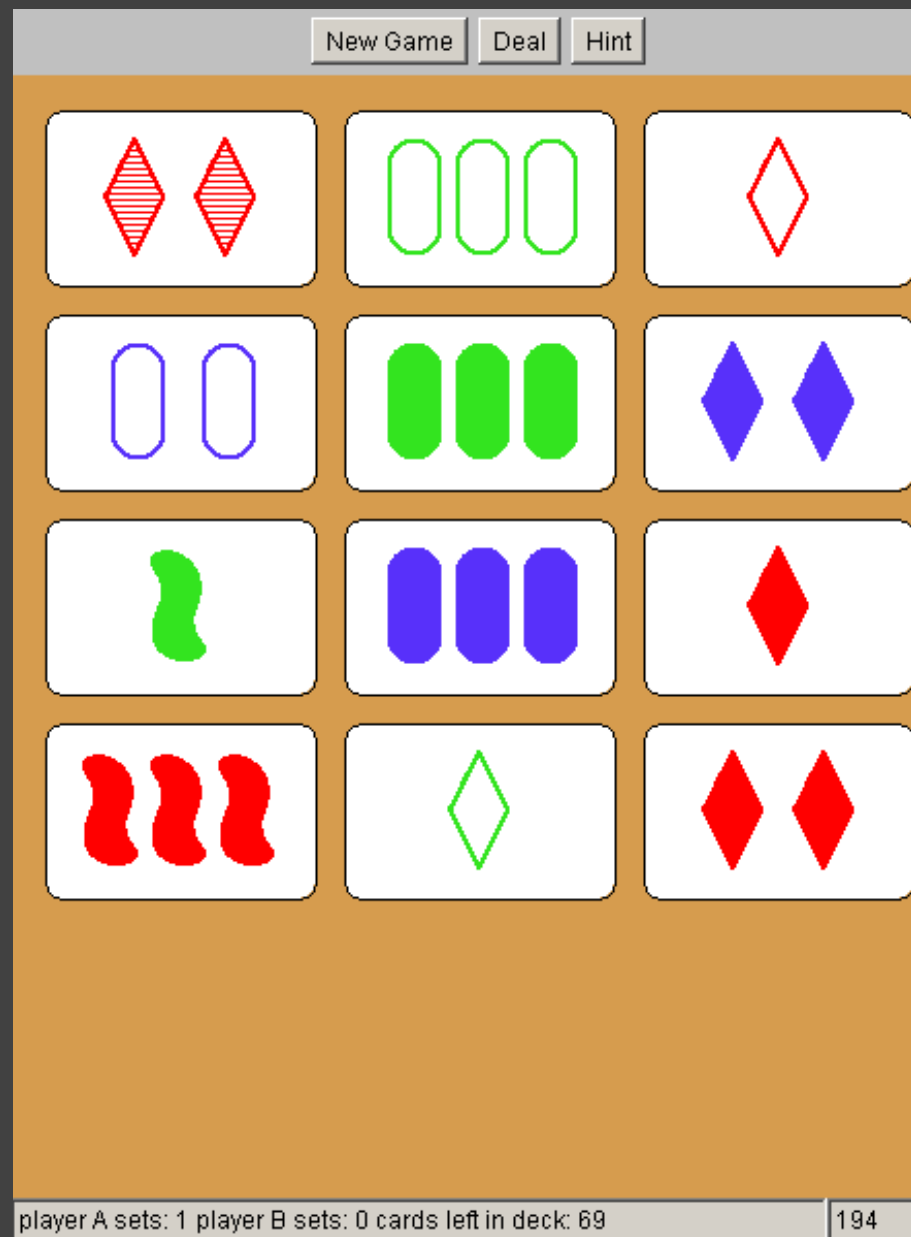

Gestalt Grouping

Gestalt Principles

Figure/Ground

Proximity

Similarity

Symmetry

Connectedness

Continuity

Closure

Common Fate

Transparency

Figure/Ground



Ambiguous

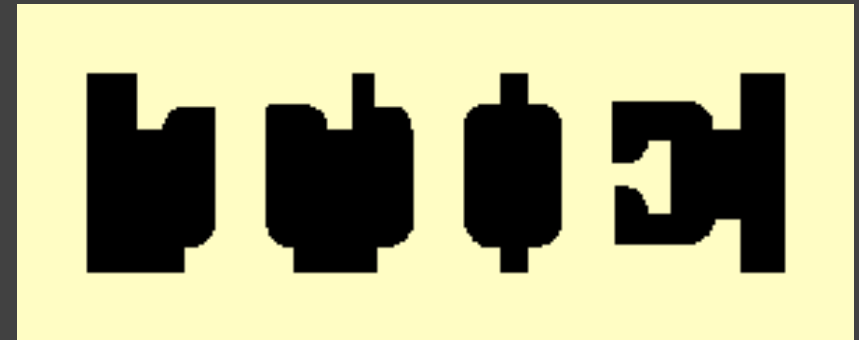

Principle of surroundedness

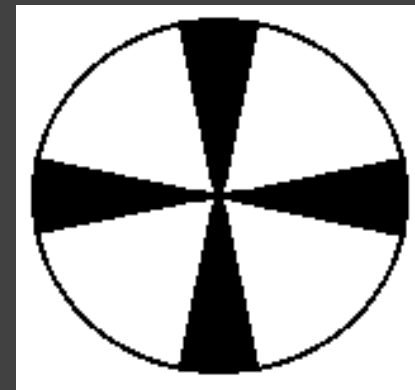

Principle of relative size

Figure/Ground



Ambiguous



Unambiguous (?)

Proximity

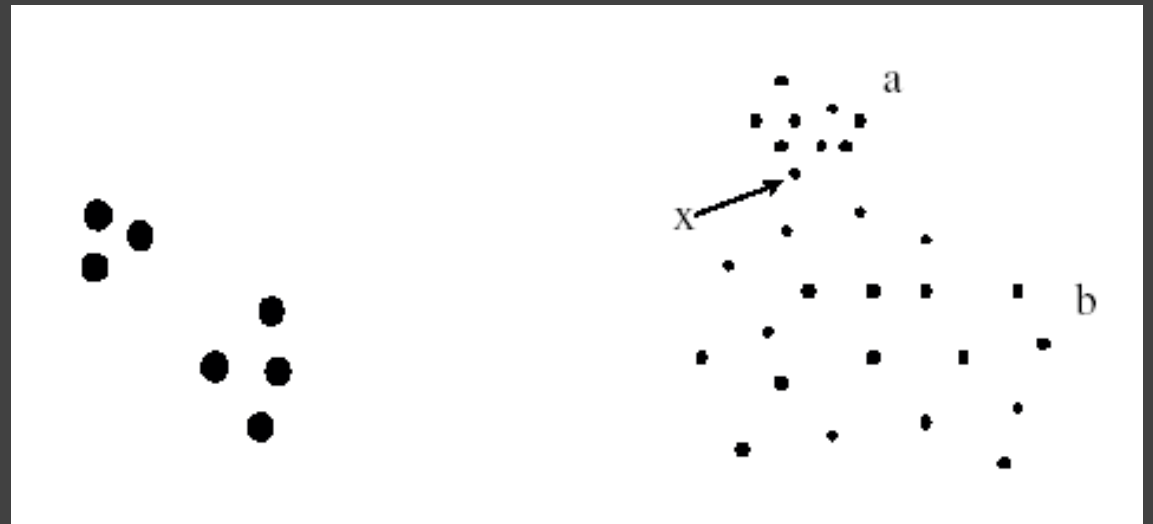
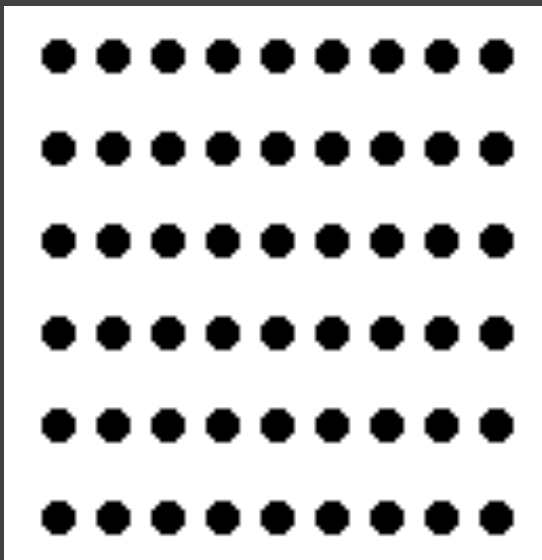
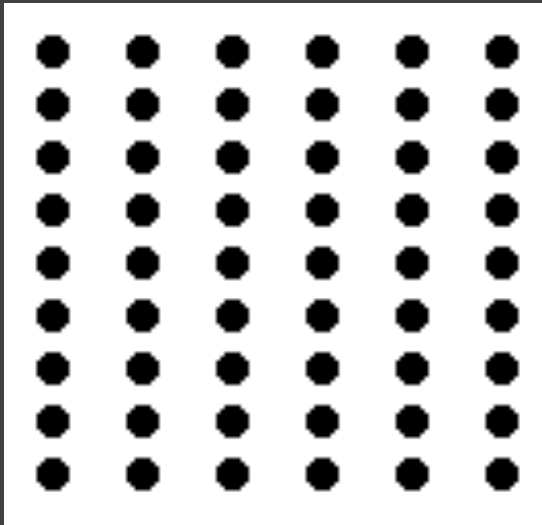

[Ware 00]

Similarity

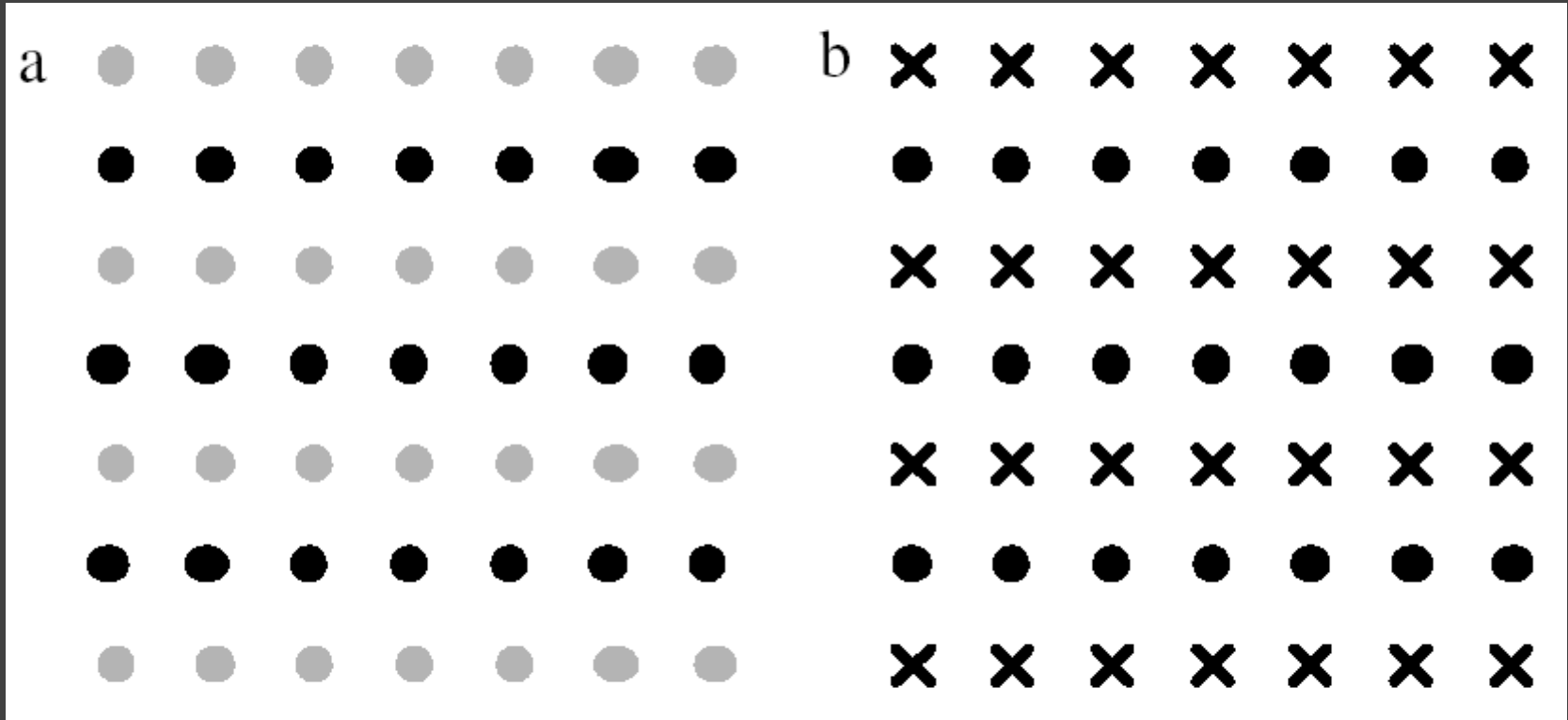

Rows dominate due to similarity [from Ware 04]

Symmetry

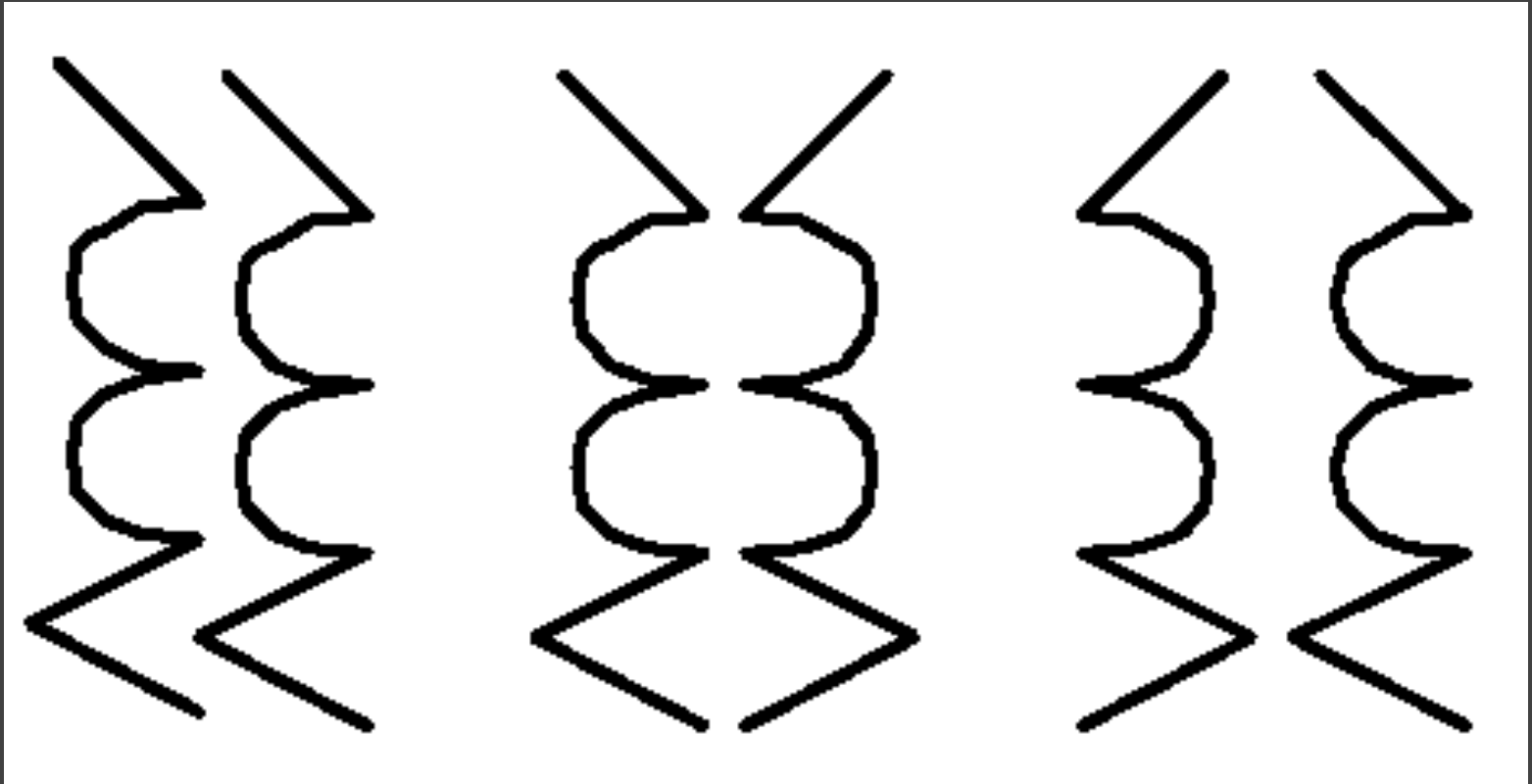

Bilateral symmetry gives strong sense of figure [from Ware 04]

Connectedness

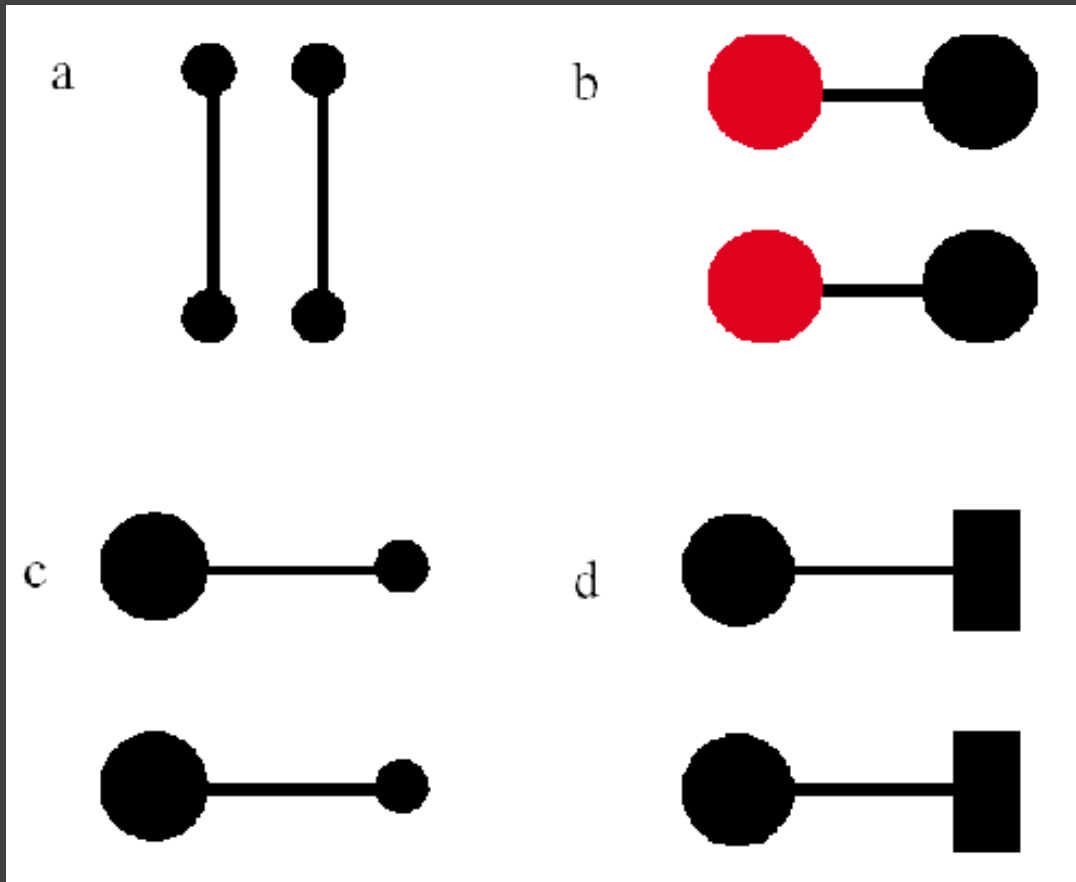

Connectedness overrules proximity, size, color shape [from Ware 04]

Continuity

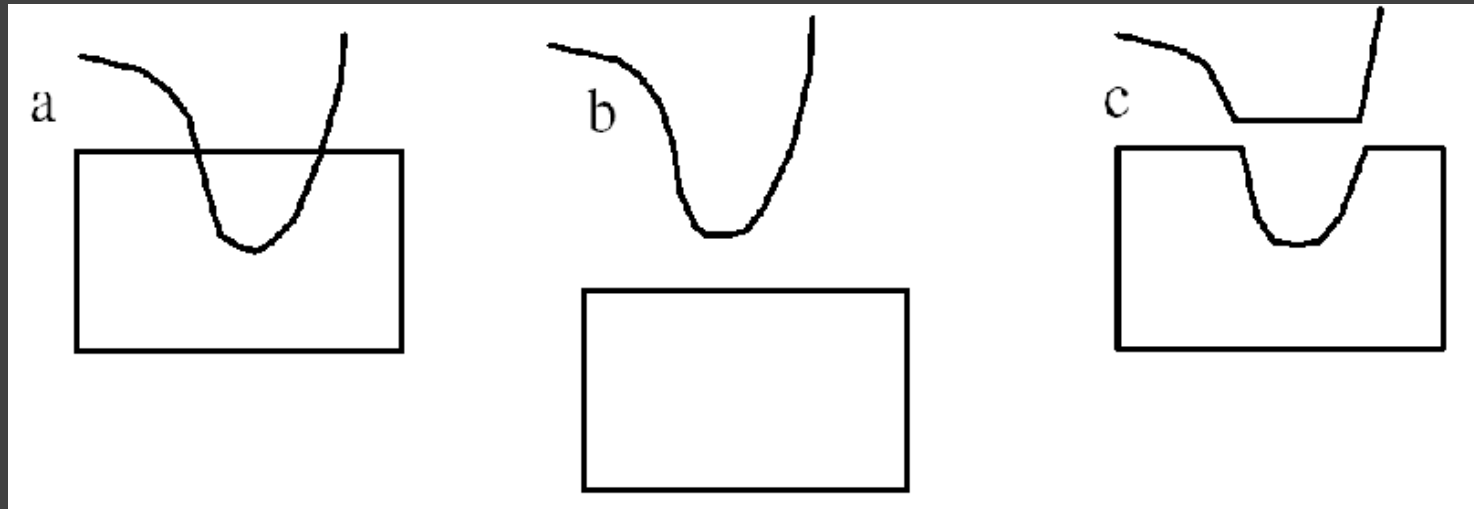

We prefer smooth not abrupt changes [from Ware 04]

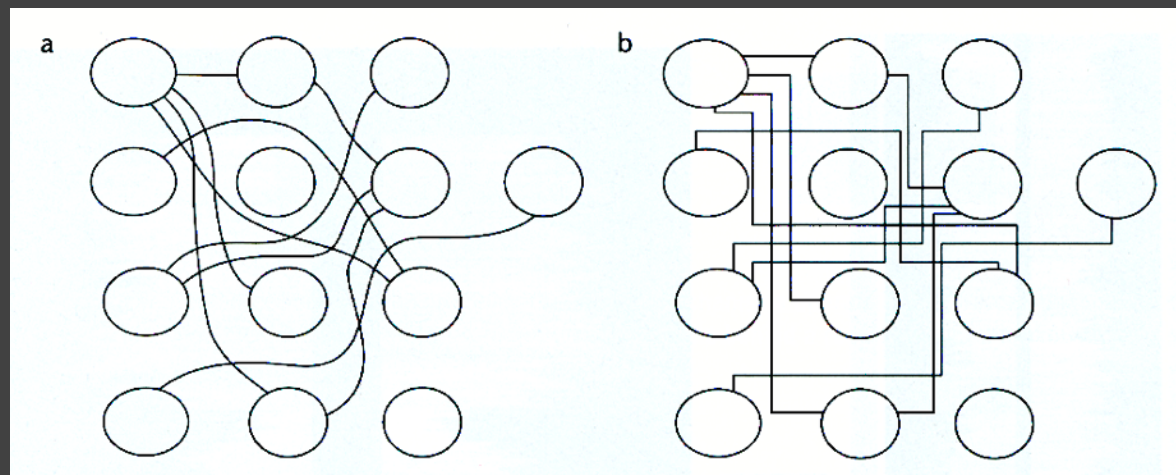

Connections are clearer with smooth contours [from Ware 04]

Continuity: Vector Fields

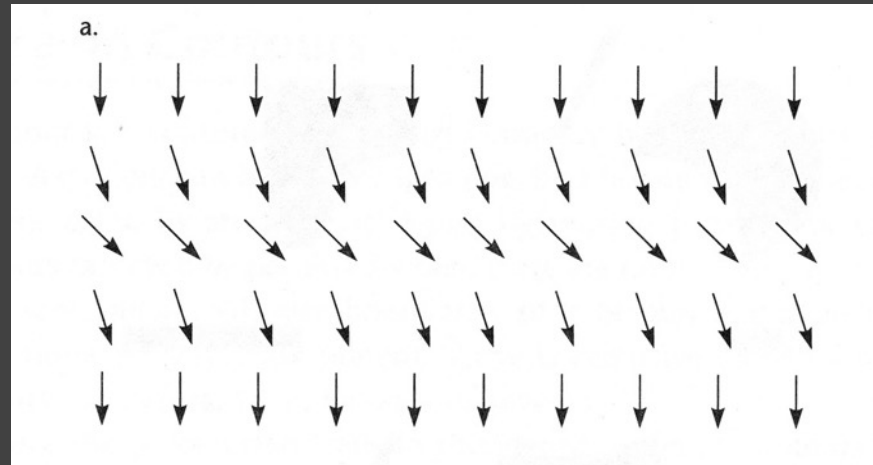

Closure

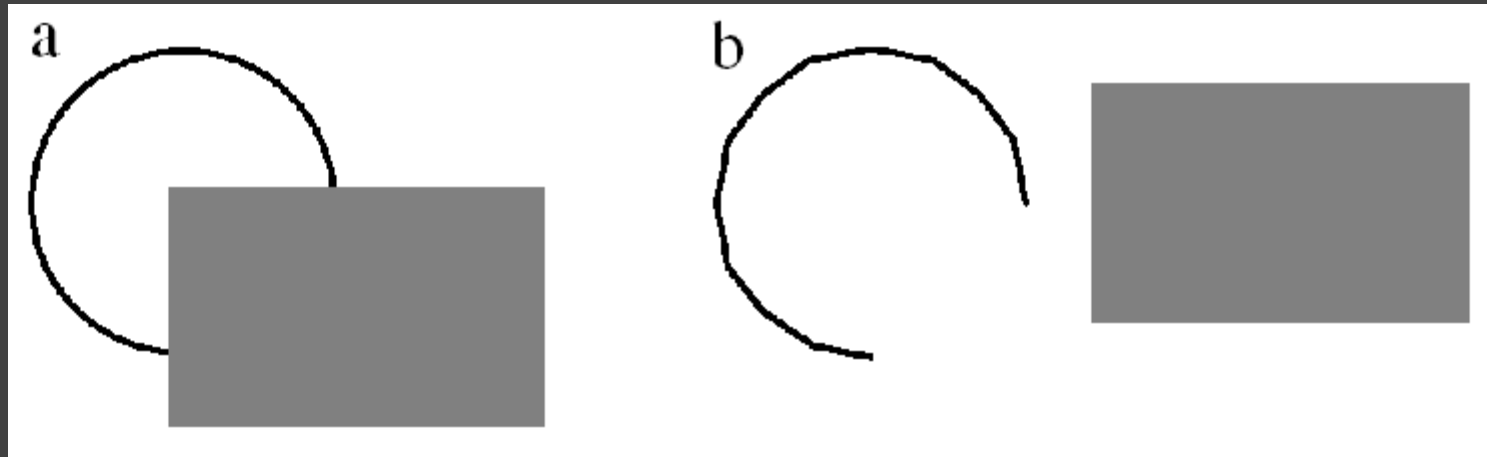

We see a circle behind a rectangle, not a broken circle [from Ware 04]

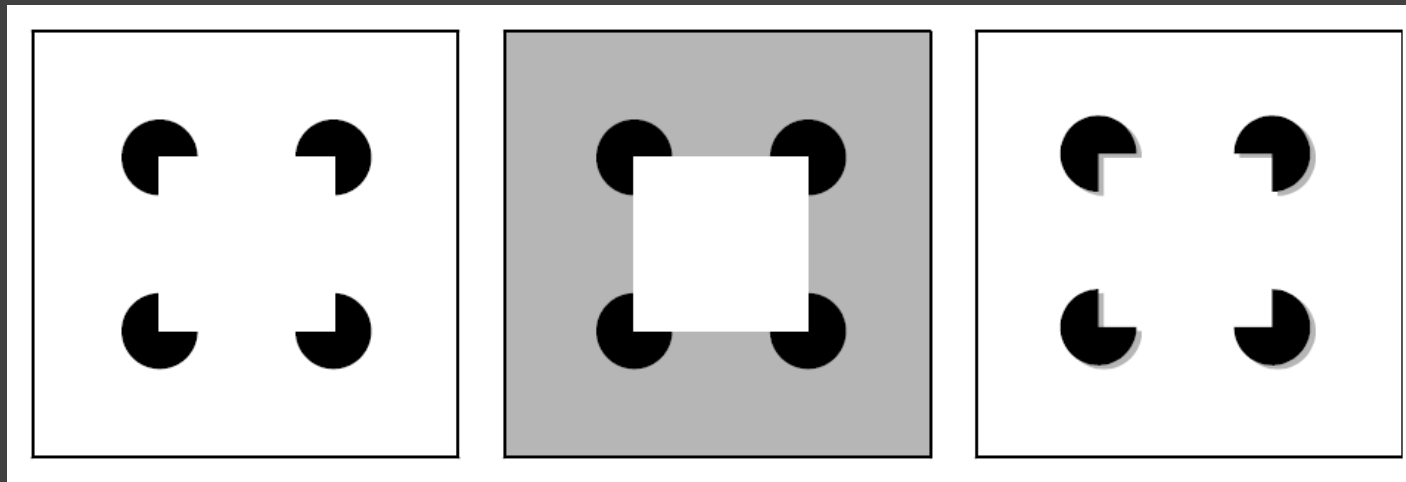

Illusory contours [from Durand 02]

Common Fate

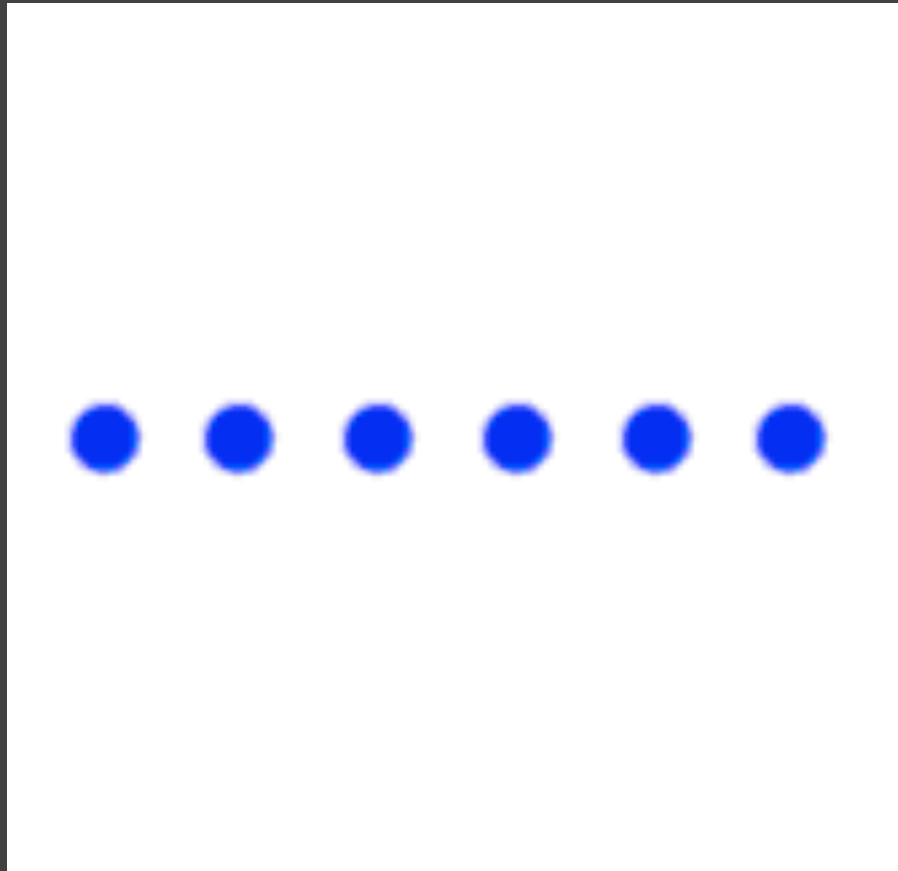

Dots moving together are grouped

Transparency



Requires continuity and proper color correspondence [from Ware 04]

Layering

Layering: Gridlines

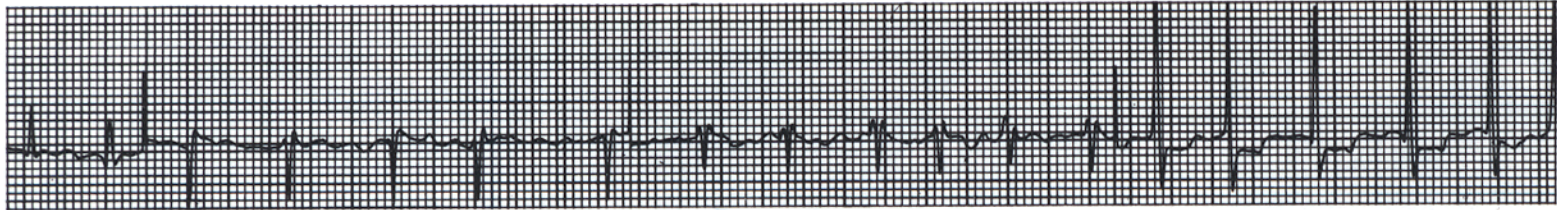

Signal and background compete above, as an electrocardiogram trace-line becomes caught up in a thick grid. Below, the screened-down grid stays behind traces from each of 12 monitoring leads:⁴

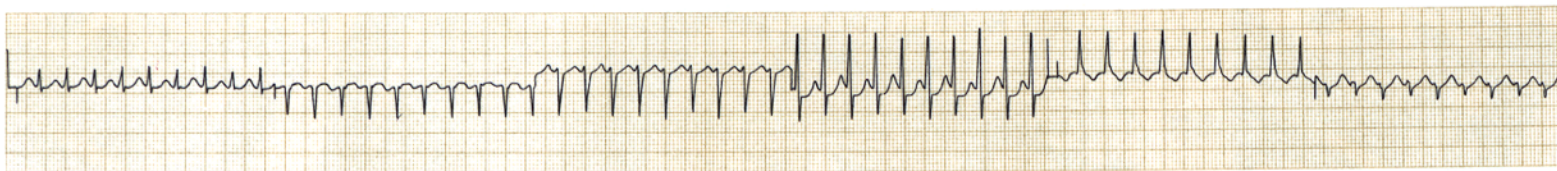

Layering: Gridlines

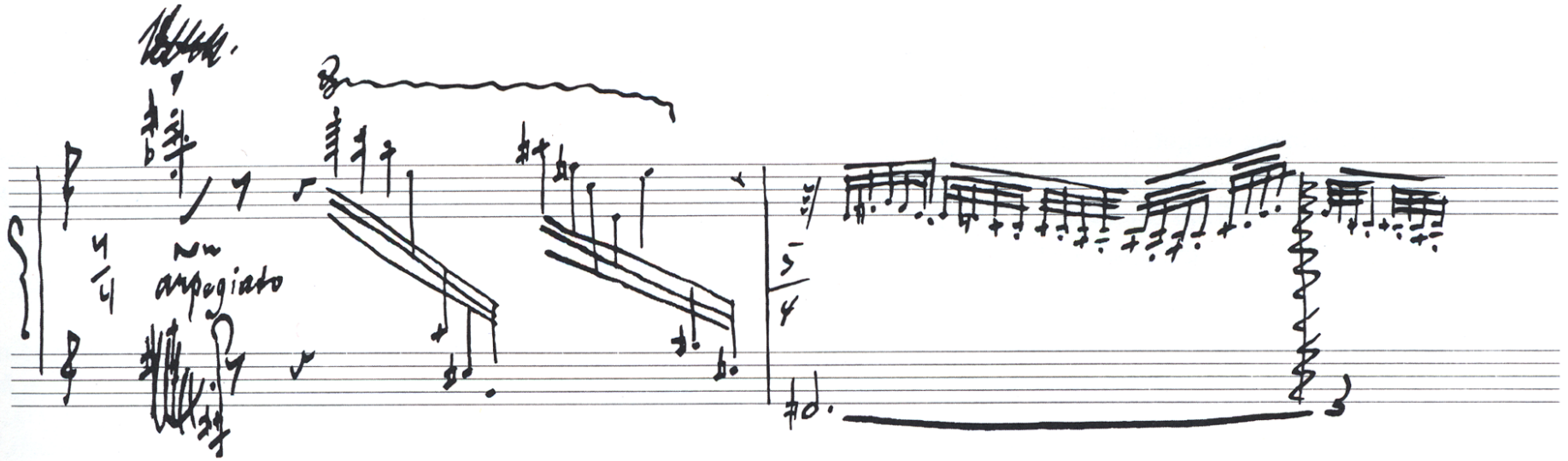
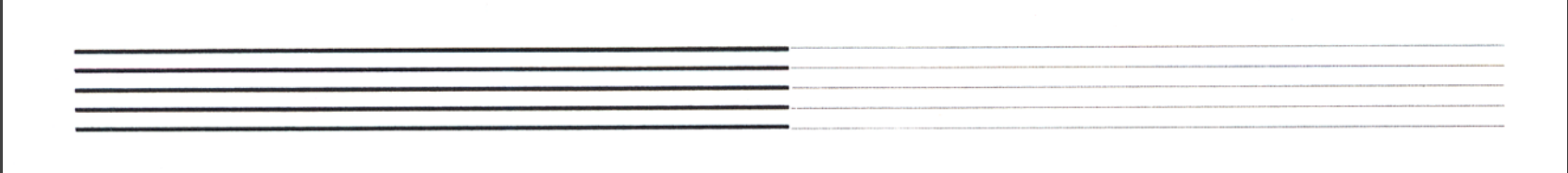

Stravinsky score [from Tufte 90]

Setting Gridline Contrast

How light can gridlines be and remain visible?
How dark can gridlines be and not distract?

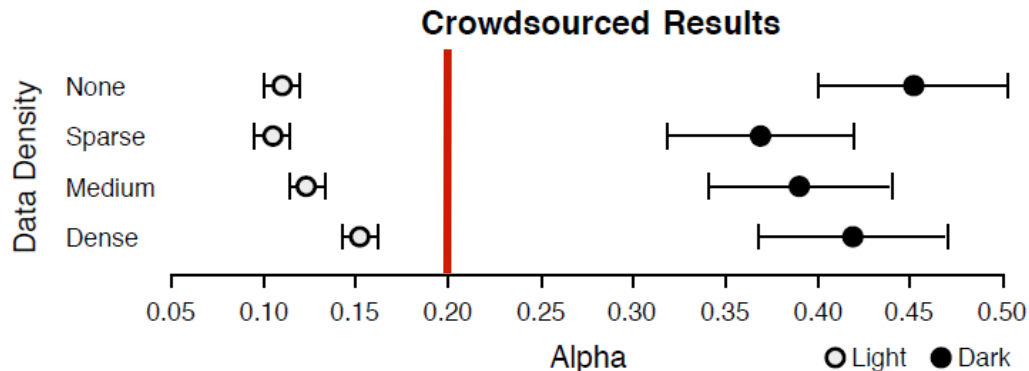
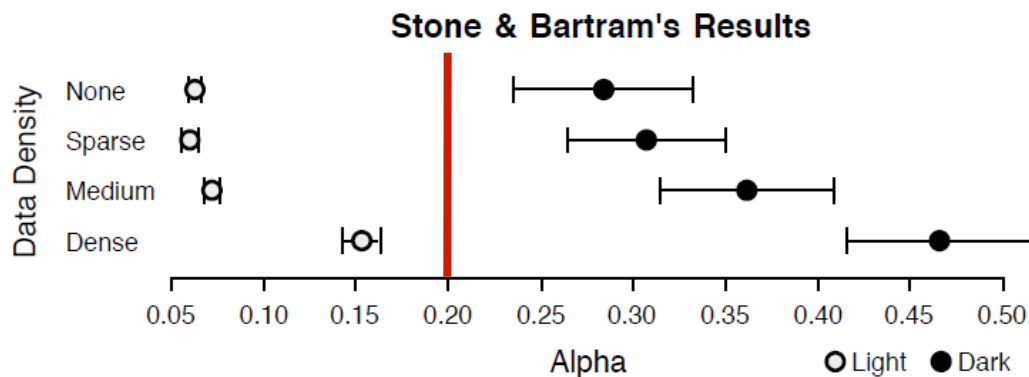

Safe setting:
20% Alpha

[Stone & Bartram 2009]

[Heer & Bostock 2010]

Layering: Color & Line Width

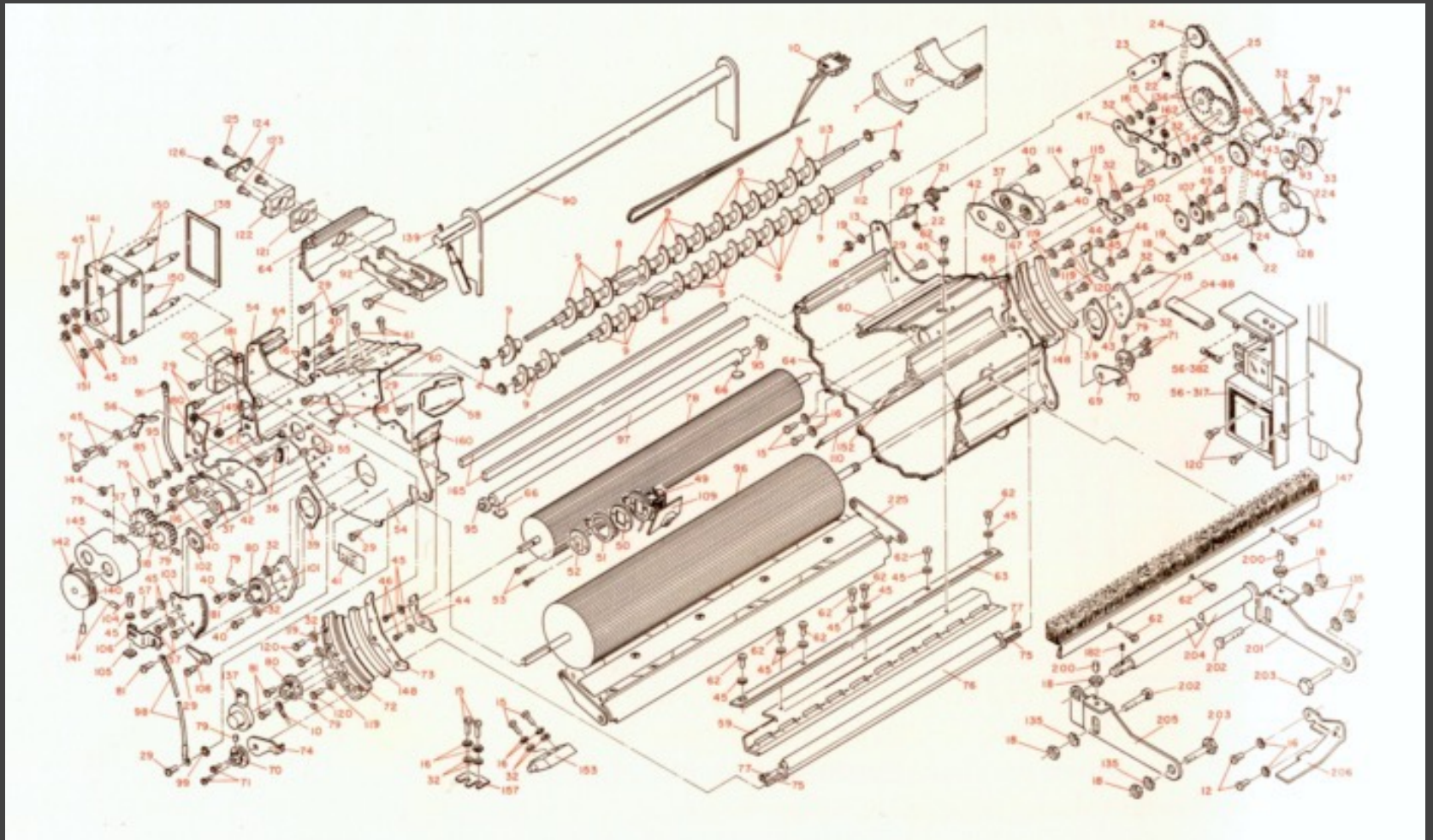

IBM Series III Copier [from Tufte 90]

Change Blindness

Change Blindness



Change Blindness



Change Blindness



Change Blindness



[Example from Palmer 99, originally due to Rock]

Demonstrations

<http://www.psych.ubc.ca/~rensink/flicker/download/>

<http://www.youtube.com/watch?v=Ahg6qcgoy4>

Summary

Choosing effective visual encodings requires knowledge of visual perception.

Visual features/attributes

Individual attributes often pre-attentive

Multiple attributes may be separable or integral

Gestalt principles provide high-level guidelines

We don't always see everything that is there!